

# BOTERA

by e-ggs



Imbottita con quattro tipologie di gomme diverse, lo studio di Botera si concentra sulla comodità. Da un cuscino paffuto si espande lo schienale, alto o basso, che porta la poltrona a dialogare con un linguaggio modulare. È proprio nelle composizioni, infatti, che Botera diventa un elemento di condivisione dal quale si sviluppa la vita sociale, abbattendo gli ultimi limiti tra domestico e contract a favore di uno spazio ibrido, morbido e personale. A Botera piace stare in compagnia, soprattutto nei luoghi pubblici, ma a casa se la passa bene anche da sola.

Padded with four different types of foam, Botera's design focuses on comfort. A chunky cushion forms the base from which the high or low backrest is developed, making this armchair ideal for use in modular arrangements. And it is precisely through its compositions that Botera brings people together and encourages them to socialise, breaking down the final boundaries between home and contract settings to create a soft, personal, hybrid space. Botera loves being in company, especially in public spaces, but at home it also enjoys being on its own.

## DIMENSIONI | DIMENSIONS

lunghezza | width: 120 cm  
larghezza | depth: 104,5 cm  
altezza | height: 85-125 cm  
altezza del sedile | seat height: 38 cm

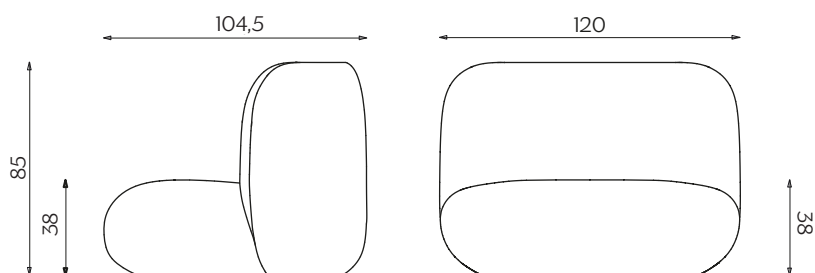

lunghezza | width: 120 cm  
larghezza | depth: 103,4 cm  
altezza | height: 125,6 cm  
altezza del sedile | seat height: 38,7 cm

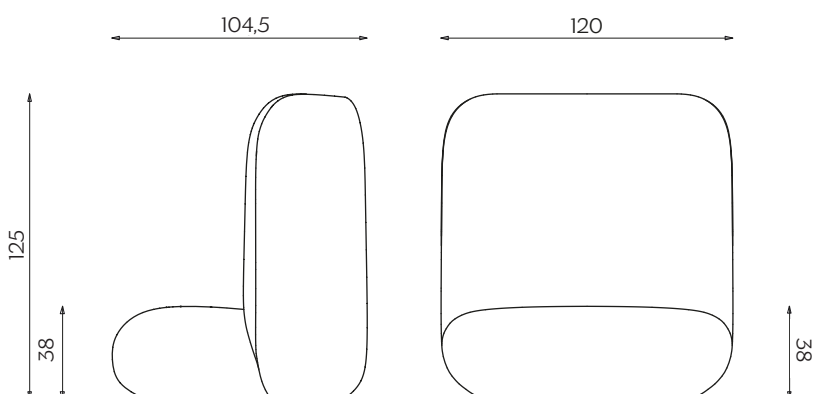

## AMBIENTE | ENVIRONMENT

interno | indoor

## DOWNLOAD | DOWNLOADS

la guida Cura e Manutenzione è disponibile su [miniforms.com](http://miniforms.com)  
Care and Maintenance guide is available at [miniforms.com](http://miniforms.com)

file 2D, 3D e fotografie sono disponibili su [miniforms.com](http://miniforms.com)  
2D, 3D files and hi-res images are available at [miniforms.com](http://miniforms.com)

# FINITURE | FINISHES

## TESSUTI | FABRICS

A

### Salò

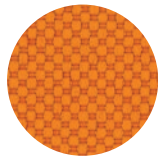

Arancio  
Orange

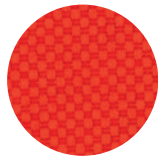

Rosso  
Red



Marmellata  
Jam



Grigio Chiaro  
Light Grey



Marrone  
Brown

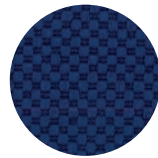

Blu Notte  
Midnight Blue

### Loop

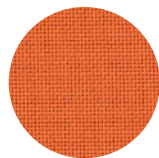

Arancione  
Orange



Lime

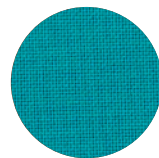

Turchese  
Turquoise

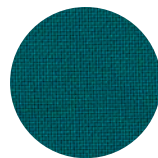

Ottanio  
Teal Green

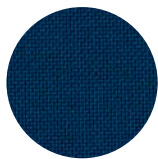

Blu Scuro  
Dark Blue



Testa di Moro  
Dark Brown

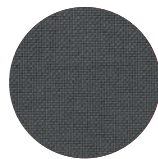

Grigio Fumo  
Smoke Grey

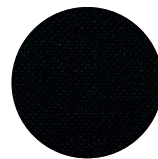

Nero  
Black

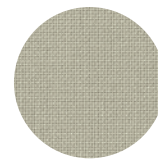

Avorio  
Ivory

## TESSUTI | FABRICS

A

### Tramè



Beije

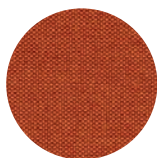

Arancio  
Orange

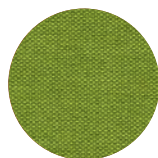

Mela  
Apple

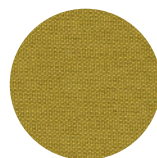

Senape  
Mustard

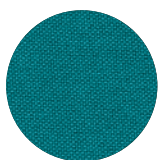

Pavone  
Peacock

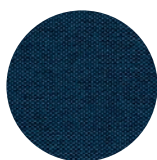

Blu Elettrico  
Electric Blue



Nero  
Black

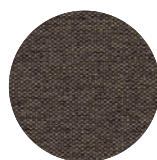

Crijio Scuro  
Dark Grey

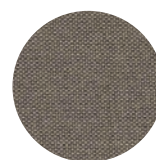

Tortora  
Dove Grey

### Madrid

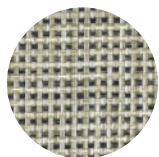

Burro  
Butter

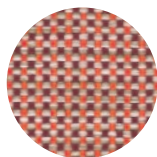

Melograno  
Pomegranate

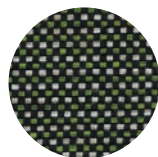

Menta  
Mint

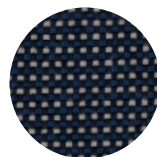

Notte  
Night

FINITURE | FINISHES  
TESSUTI | FABRICS

B

Kvadrat Relate



Rosa  
Pink

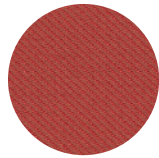

Rosso  
Red

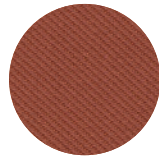

Terra  
Ground



Snack

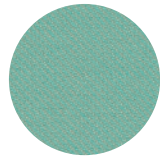

Menta  
Mint



Verde Bosco  
Forest Green

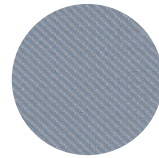

Nuvolo  
Cloudy

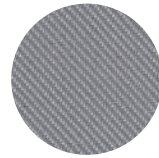

Grigio  
Grey

Lanee

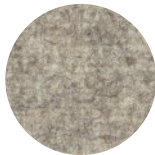

Grigio  
Grey

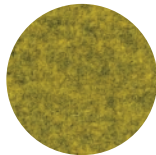

Giallo  
Yellow

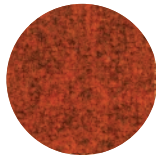

Rosso  
Red

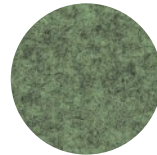

Menta  
Mint

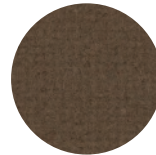

Marrone  
Brown

## TESSUTI | FABRICS

B

### Torrilana Gubbio

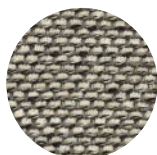

Sale e Pepe  
Salt and Pepper

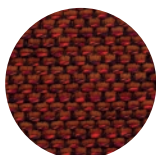

Ambra  
Amber

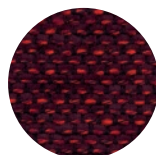

Bordeaux

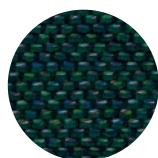

Verde Petrolio  
Petrol Green

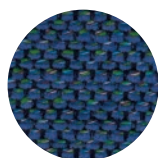

Blu Elettrico  
Electric Blue



Castagna  
Walnut

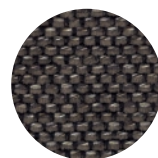

Tortora  
Dove Grey

### Mesh

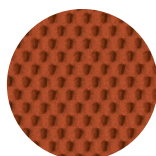

Rosso Corallo  
Coral Red

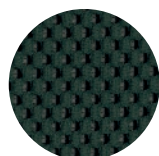

Verde Salvia  
Sage Green

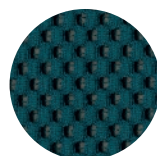

Foglia di Tè  
Teal

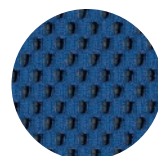

Blu Neon  
Neon Blue

FINITURE | FINISHES

TESSUTI | FABRICS



Shelter Velvet



Crema  
Cream



Rosa Intenso  
Intense Rose



Terra di Siena  
Burnt Sienna



Cammello  
Camel



Verde  
Green

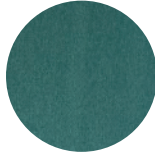

Turchese  
Turquoise



Blu Notte  
Midnight Blue



Testa di Moro  
Dark Brown

Kvadrat Field 2

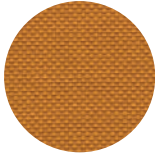

Zafferano  
Saffron-Yellow

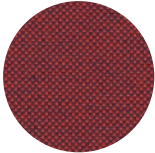

Ciliegia  
Cherry

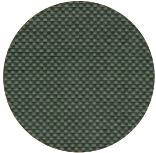

Menta  
Mint

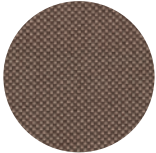

Nocciola  
Hazel

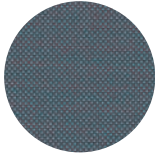

Zucchero  
Sugar

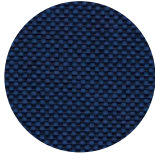

Blu  
Blue

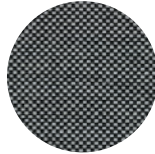

Sale e Pepe  
Salt and Pepper

Torilana Brionne



Black and White

## TESSUTI | FABRICS

C

### Vescom Harding

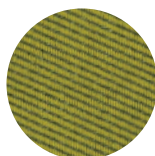

Ciallo  
Yellow

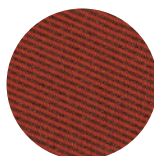

Rosso  
Red

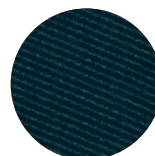

Petrolio  
Blue-Green

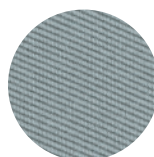

Grigio Chiaro  
Light Grey

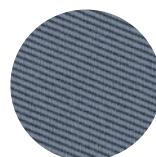

Nuvolo  
Cloudy

### Vescom Rolla

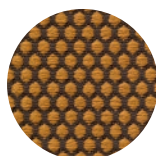

Mostarda  
Mustard

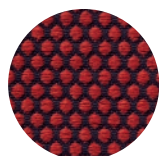

Ciliegia  
Cherry

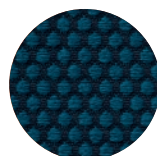

Blu Pavone  
Peacock

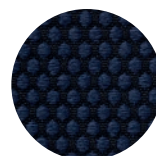

Blu Notte  
Midnight Blue

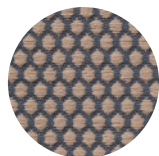

Latte  
Steamed Milk

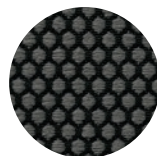

Antracite  
Anthracite

### Torrilana Rakam



Bacca  
Berry



FINITURE | FINISHES

TESSUTI | FABRICS

D

Cloud



Panna  
Cream

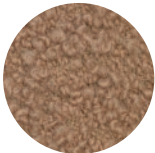

Noce  
Walnut

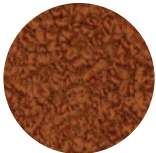

Nocciola  
Hazelnut

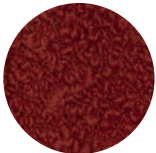

Bordeaux

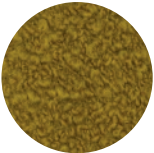

Senape  
Mustard

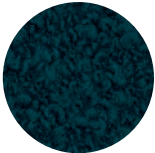

Petrolio  
Blue-Green



Blu Notte  
Night Blue

Maharam Merit

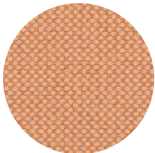

Salmone  
Salmon

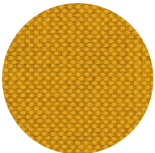

Ciallo  
Yellow

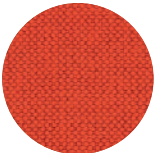

Rosso Corallo  
Coral Red



Marrone  
Brown

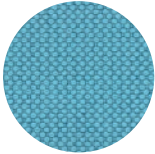

Celeste  
Sky Blue

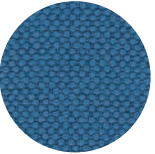

Blu Cobalto  
Cobalt Blue

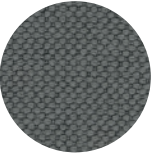

Grigio  
Grey

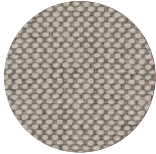

Sale e Pepe  
Salt and Pepper

## TESSUTI | FABRICS

D

### Rohi Sera

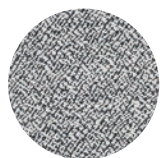

Pepper

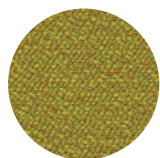

Tivoli

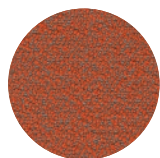

Clow

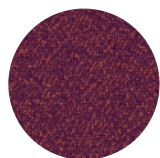

Berry

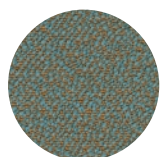

Mirage

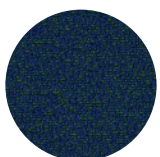

Mare

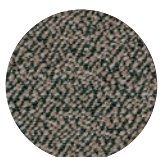

Walnut



Rosewood

### Rohi Mica

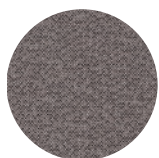

Pepper

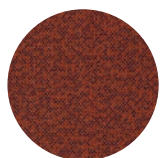

Indio

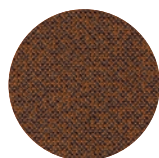

Amber

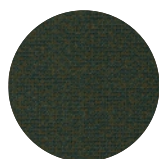

Jungle



Mud

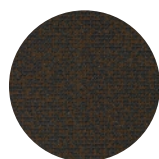

Secret

## FINITURE | FINISHES

### TESSUTI | FABRICS

E

#### Kvadrat Steelcut Trio 3

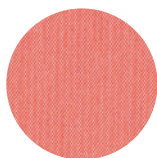

Arancia Rossa  
Red Orange



Pavone  
Peacock



Pesca  
Peach



Sale e Pepe  
Salt and Pepper



Elettricità  
Electricity

#### Esedra Tricot



Sabbia  
Sand



Borgogna  
Burgundy



Niagara  
Niagara Blue