

BATTENTE | REGULAR DOOR

caratteristiche dimensionali | dimensional characteristics

MODULARITÀ ORIZZONTALE - HORIZONTAL MODULES

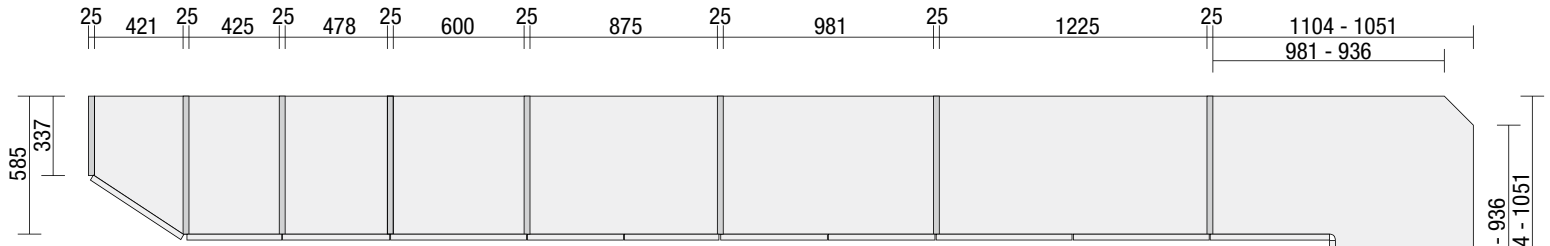

MODULARITÀ VERTICALE - VERTICAL MODULES

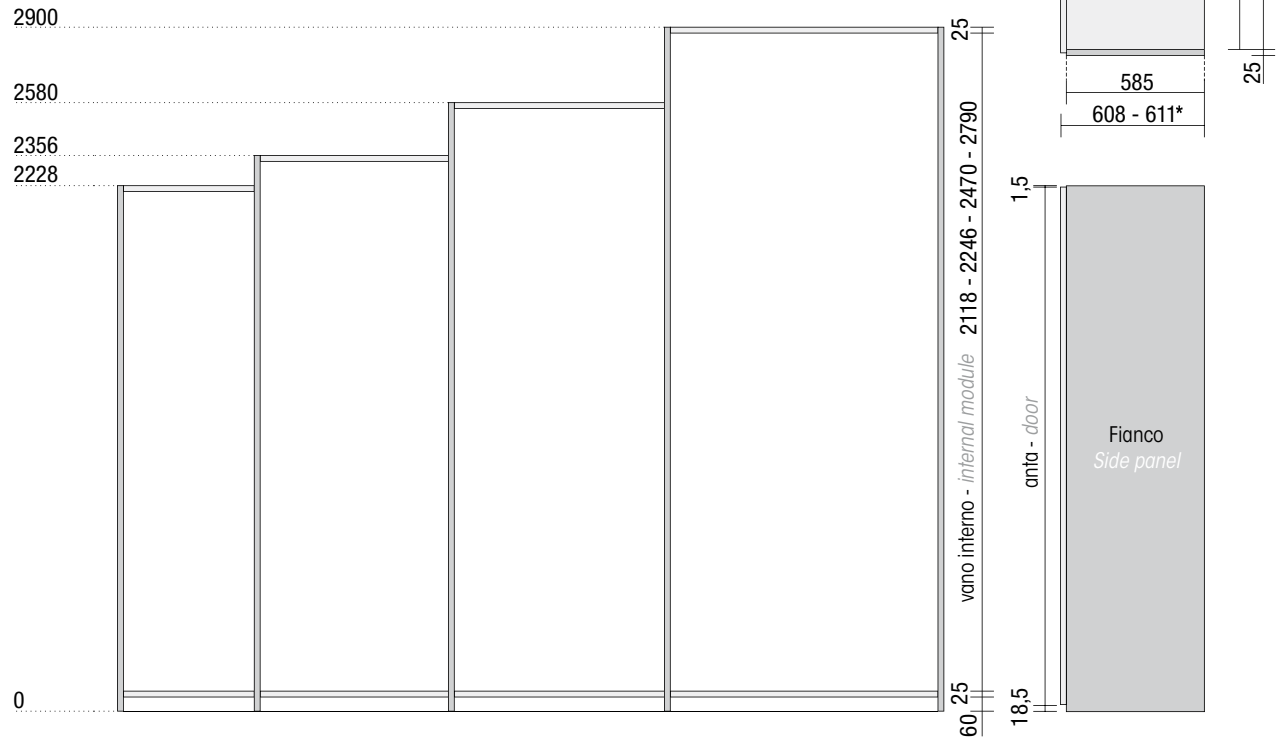

COMPONIBILITÀ - MODULARITY

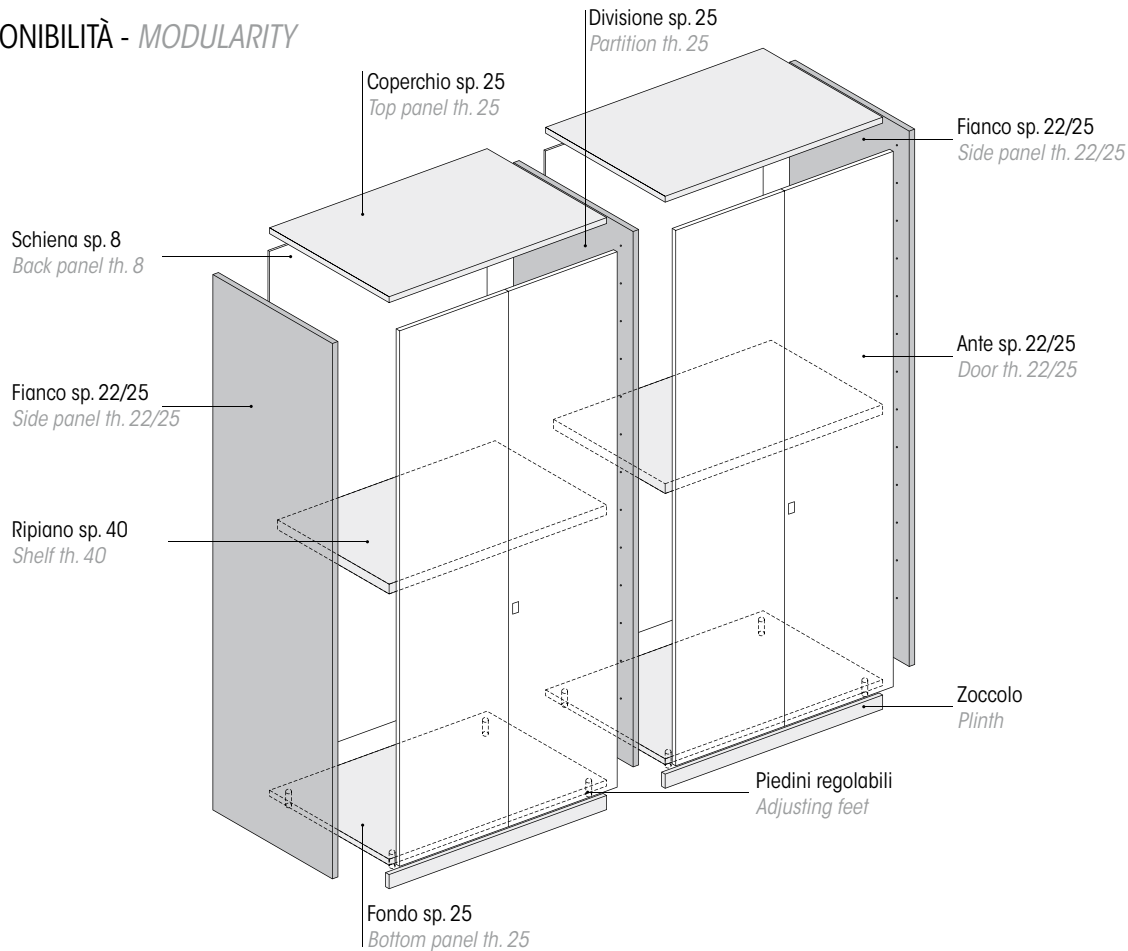

* Prof. totale armadio:
608 con anta sp. 22
611 con anta sp. 25
621 con anta Glass up

* Wardrobe total depth:
608 with door th. 22
611 with door th. 25
621 with Glass up door

BATTENTE | *REGULAR DOOR*

componibilità orizzontale | *horizontal modularity*

larghezza <i>length</i>		larghezza <i>length</i>		larghezza <i>length</i>	
475		2037		3150	
528		2175		3175	
650		2275		3287	
925		2281		3425	
1031		2328		3546	
1275		2487		3625	
1375		2525		3775	
1481		2540		4049	
1534		2662		4293	
1656		2725		4400	
1778		2784		4525	
1825		2906		4537	
1900		3043		5025	

BATTENTE | REGULAR DOOR

caratteristiche dimensionali | dimensional characteristics

TERMINALE - END UNIT

Pianta Dx - Plan Rh

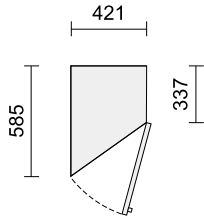

Pianta Sx - Plan Lh

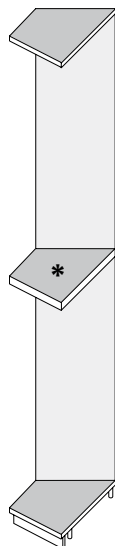
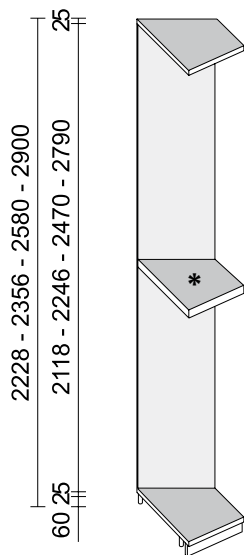

* vano attrezzabile solo con ripiani sagomati
* compartment to be equipped only with shaped shelves*

TERMINALE - END UNIT

P. - D. 585 - 337

L. 421

H. 2228 - 2356 - 2580 - 2900

con 1 anta battente - with 1 regular door L. 499

Dotazione interna standard - Standard internal equipment:

N.1 ripiano - 1 shelf

N.B.: Solo cerniere cromate, no brunito - N.B.: only chromed hinges, no brown finish

ANGOLO - CORNER UNIT

Pianta - Plan

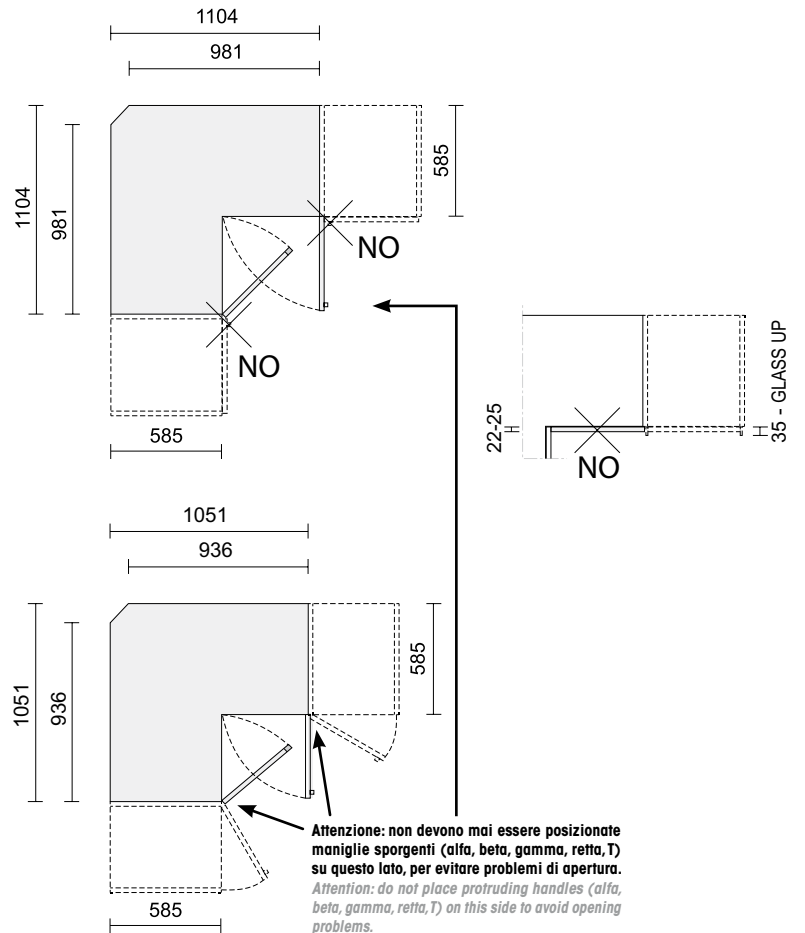

Attenzione: non devono mai essere posizionate maniglie sporgenti (alfa, beta, gamma, retta, T) su questo lato, per evitare problemi di apertura.
Attention: do not place protruding handles (alfa, beta, gamma, retta, T) on this side to avoid opening problems.

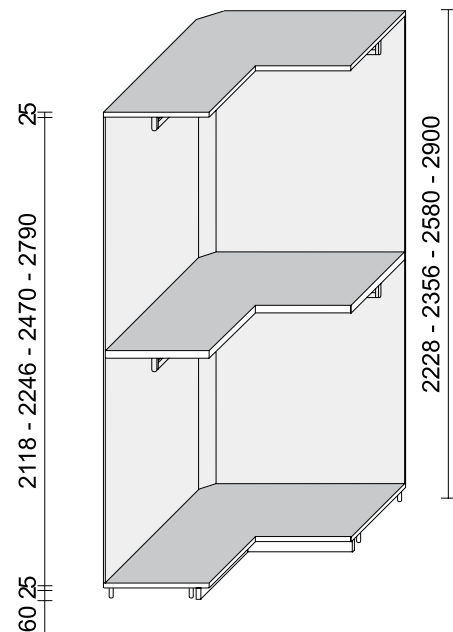

ANGOLO - CORNER UNIT

P. - D. 1104 x L. 1104

P. - D. 1051 x L. 1051

H. 2228 - 2356 - 2580 - 2900

con 2 ante battenti - with 2 regular doors L. 446 - L. 499

Dotazione interna standard - Standard internal equipment:

N.1 ripiano, N.2 tubi appendiabiti - 1 shelf, 2-clothes hangers

N.B.: Solo cerniere cromate, no brunito - N.B.: only chromed hinges, no brown finish

BATTENTE | REGULAR DOOR

caratteristiche dimensionali | dimensional characteristics

ANGOLO ESTERNO - EXTERNAL CORNER

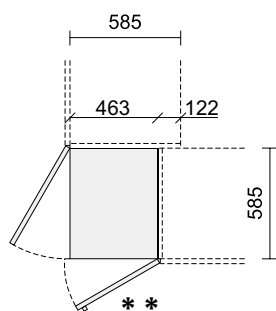

**** Per l'apertura dell'anta indicata è necessaria la maniglia (sarà esclusivamente destra). L'altra anta sarà esclusivamente sinistra mod. Simply o Young. Per l'apertura di quest'anta non è necessario l'utilizzo della maniglia che è optional.**

**** For the opening of the marked door a handle is required (only right-opening). The other door will be only left mod. Simply or Young. For the opening of this door it's not necessary the use of any handle, which is optional.**

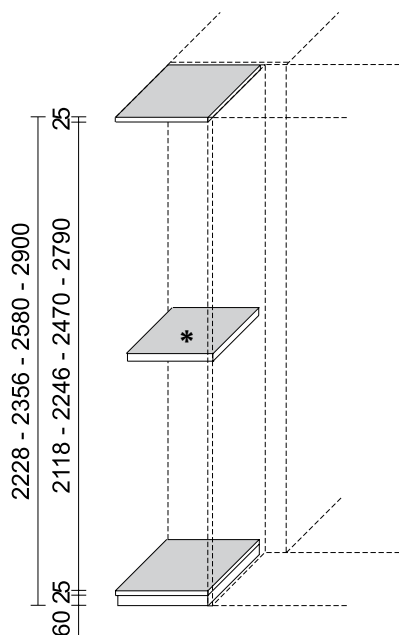

*** vano attrezzabile solo con ripiani**
*** compartment to be equipped only with shelves***

ANGOLO ESTERNO - EXTERNAL CORNER

P. - D. 585

L. 463

H. 2228 - 2356 - 2580 - 2900

con 2 ante battenti - with 2 regular doors L. 499 - L. 592

Dotazione interna standard - Standard internal equipment:

N.1 ripiano - 1 shelf

ESEMPIO DI UTILIZZO ANGOLO ESTERNO

EXAMPLE OF THE USE OF EXTERNAL CORNER

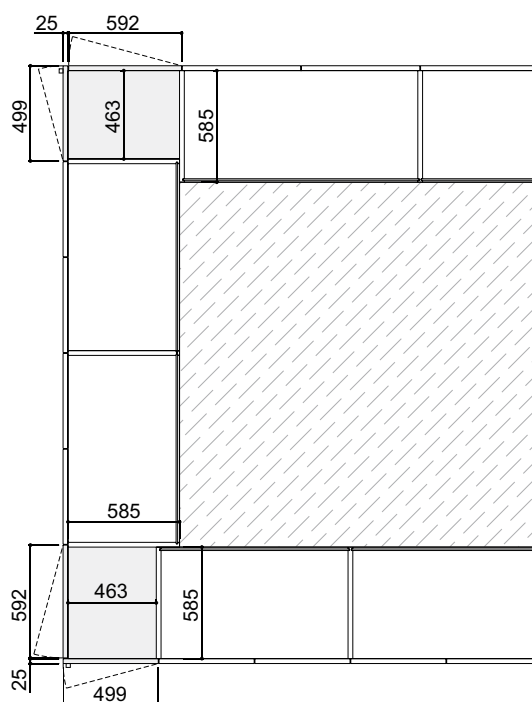

BATTENTE | REGULAR DOOR

caratteristiche dimensionali | *dimensional characteristics*

LIBRERIA TERMINALE - END BOOKCASE

Pianta Dx - Plan Rh

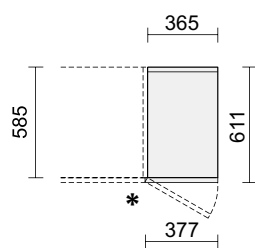

Pianta Sx - Plan Lh

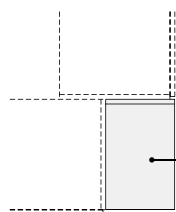
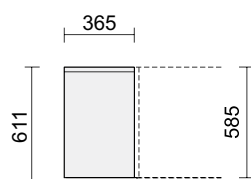

Soluzione con libreria usata come angolo
Solution with bookcase used as a corner element

* Disponibile con o senza anta.
Per l'apertura dell'anta non è necessario l'utilizzo della maniglia che è optional.

* Available with or without door.
For the opening of the door it's not necessary the use of any handle, which is optional.

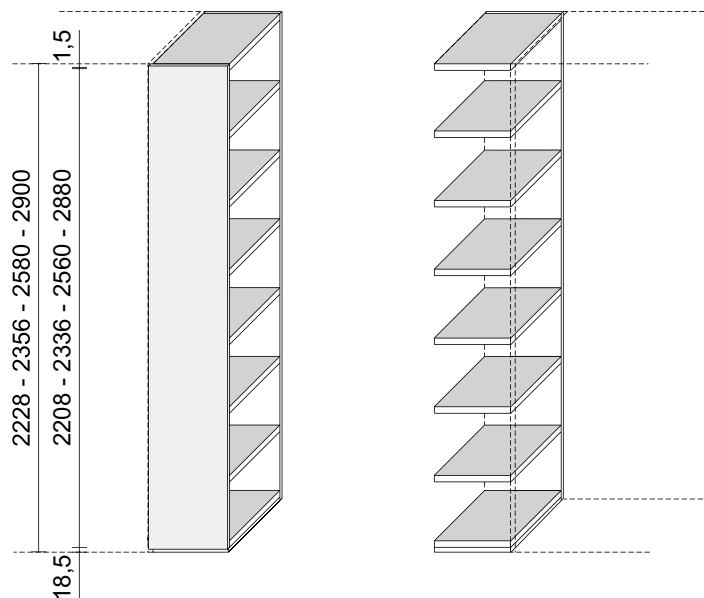

LIBRERIA TERMINALE - END BOOKCASE

P. - D. 585

L. 365

H. 2228 - 2356 - 2580 - 2900

con 1 anta battente optional - with 1 regular door, optional L. 377

Dotazione interna standard - *Standard internal equipment:*

H. 2228 - 2356 - 2580 = N. 8 ripiani - H. 2228 - 2356 - 2580 = N. 8 shelves

H. 2900 = N. 9 ripiani - H. 2900 = N. 9 shelves

Attenzione: I ripiani sono distanziati in egual misura l'uno dall'altro. Non è possibile spostare il ripiano in altre posizioni.

Attention: shelves are placed at an equal distance one from the other. It's not possible to move the shelf in other positions.

LIBRERIA CENTRALE - CENTRAL BOOKCASE

Pianta - Plan

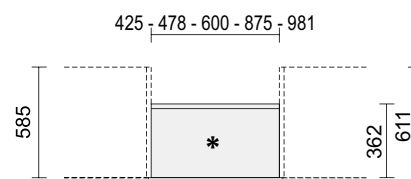

* Da posizionare centralmente sempre tra due armadi.

* Always to be placed between two wardrobes.

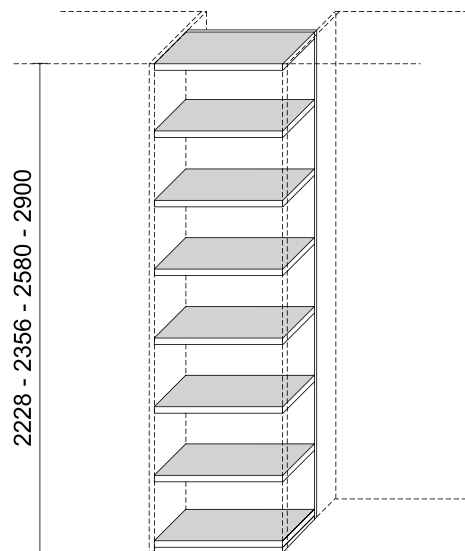

LIBRERIA CENTRALE - CENTRAL BOOKCASE

P. - D. 362

L. 425 - 478 - 600 - 875 - 981

H. 2228 - 2356 - 2580 - 2900

Dotazione interna standard - *Standard internal equipment:*

H. 2228 - 2356 - 2580 = N. 8 ripiani - H. 2228 - 2356 - 2580 = N. 8 shelves

H. 2900 = N. 9 ripiani - H. 2900 = N. 9 shelves

Attenzione: I ripiani sono distanziati in egual misura l'uno dall'altro. Non è possibile spostare il ripiano in altre posizioni.

Attention: shelves are placed at an equal distance one from the other. It's not possible to move the shelf in other positions.

MODULO CON CASSETTI ESTERNI - *MODULE WITH EXTERNAL DRAWERS*

MODULO ESCLUSO DI FIANCHI O DIVISIONI - *SIDE PANELS AND PARTITIONS NOT INCLUDED IN THE UNIT*

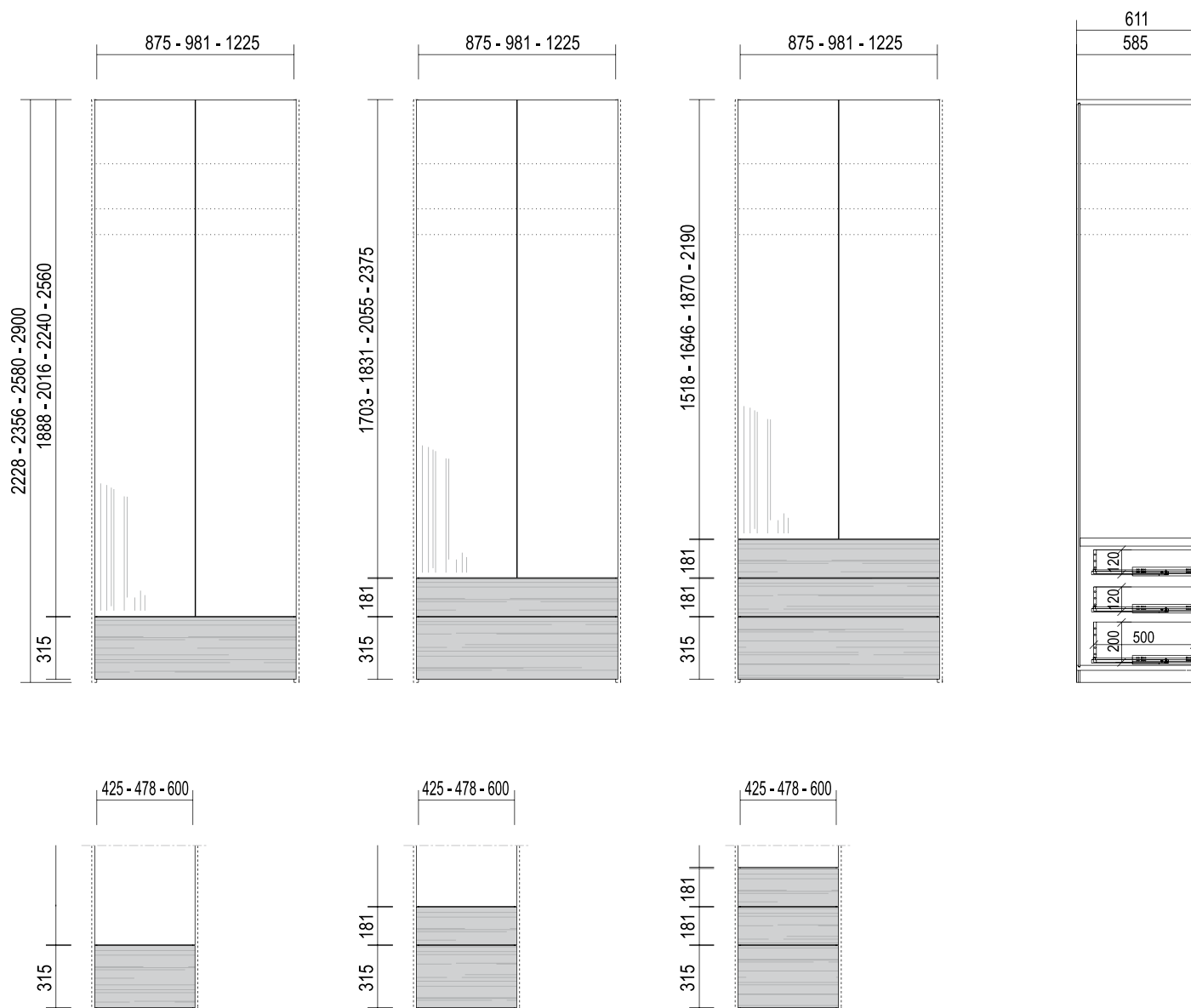

ATTENZIONE: I cassetti dello spessore di 25 mm sono disponibili solamente con maniglia a gola Tecno oppure con maniglie (esclusa la tipologia Alfa - Beta L. 655 - Gamma - Vip - Dama - Monitor - T - Total - serratura con chiave; le maniglie Beta L. 335 si possono impiegare solamente sui cassetti per vano 875 - 981 - 1225).

Per questo motivo i cassetti esterni si possono abbinare solamente ad ante sp. 25 mm Tecno e Simply.

ATTENTION: drawers with thickness 25 mm are available only with built-in handle Tecno or with handles (except for types Alfa - Beta L. 655 - Gamma - Vip - Dama - Monitor - T - Total - lock with key; handles Beta L. 335 can be used only for drawers w. 875 - 981 - 1225).
For this reason, external drawers can be matched to doors th. 25 mm Tecno and Simply.

MODULO TV - *TV UNIT*

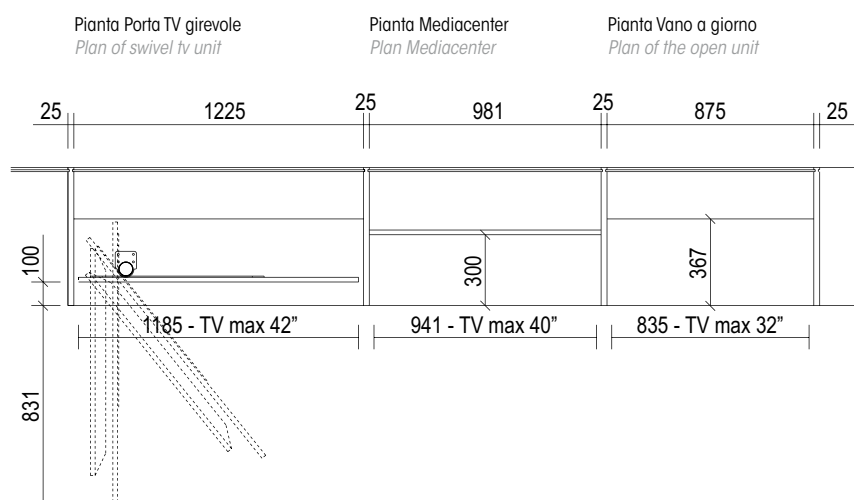
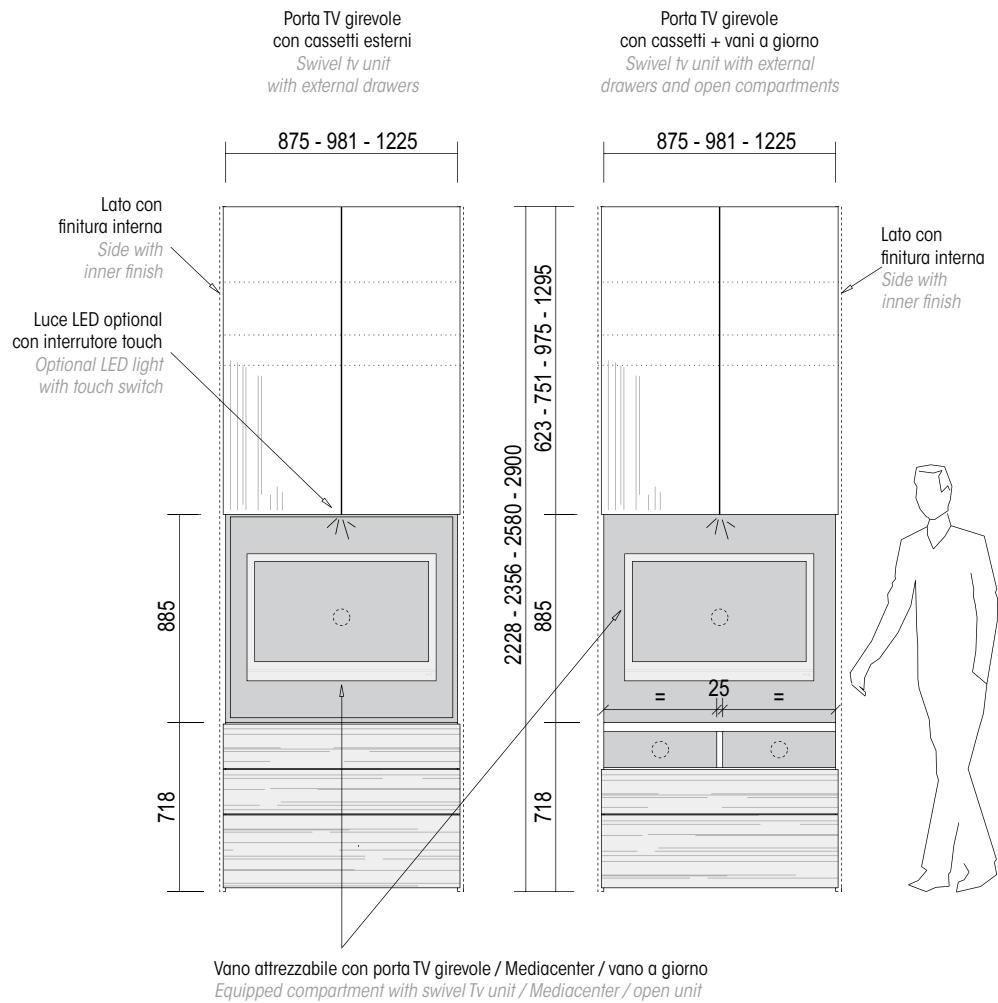

MODULO TV - TV UNIT



ABBINAMENTI - MATCHING

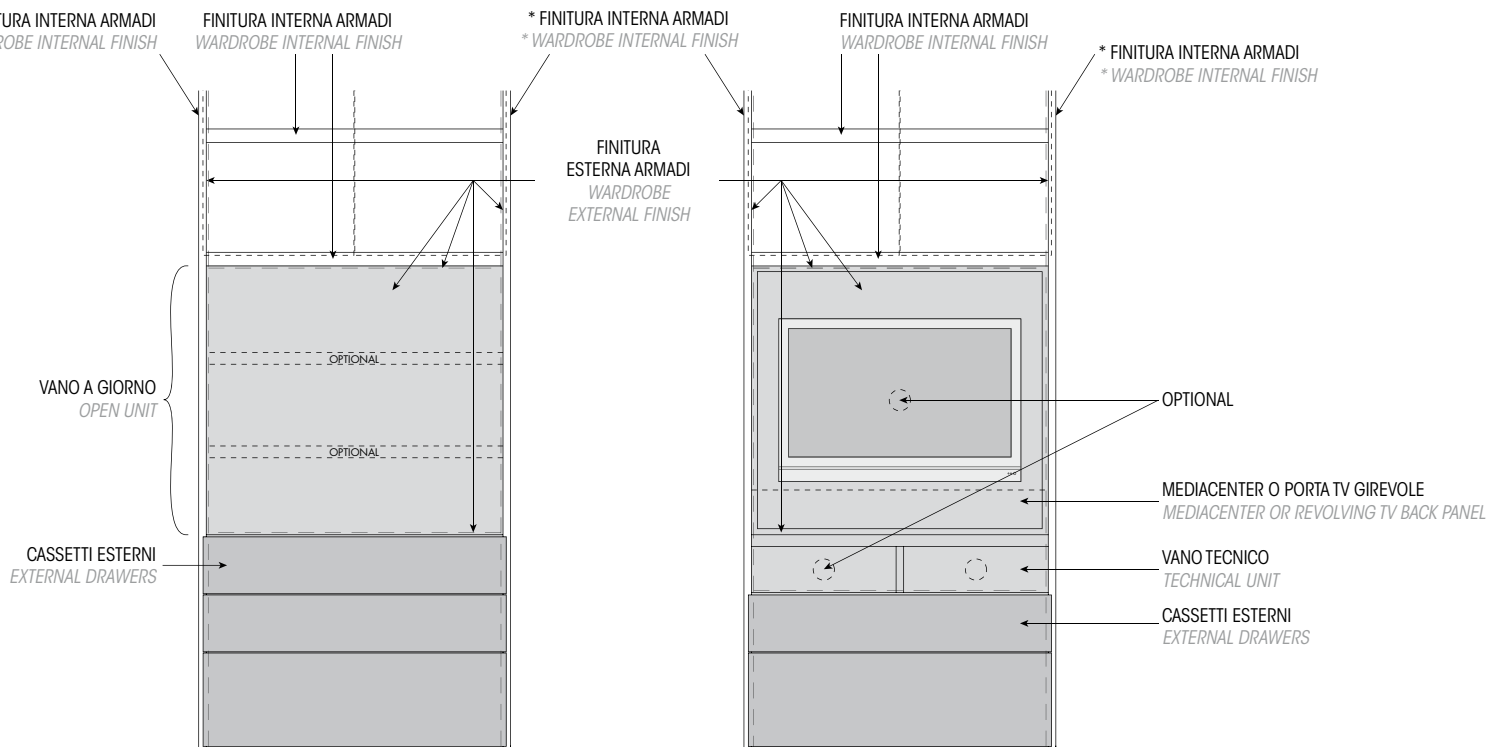

* Nel caso di modulo TV / Mediacycenter / Vano a giorno posizionato come vano finale di un armadio, il fianco avrà due lati con finitura esterna (disponibile con maggiorazione)

* In case of TV unit / Mediacycenter / Open unit placed at the end of a wardrobe, the side panel will be supplied with both faces in the external finish (available with surcharge)

BATTENTE | *REGULAR DOOR*

utilizzo fianchi | *use of side panels*

FIANCO - *SIDE PANEL*



Pianta - *Plan*

25/22
H

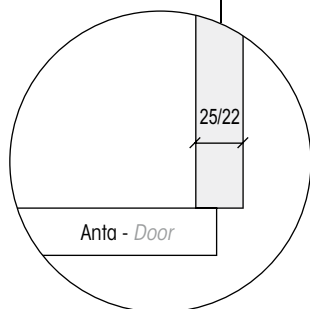
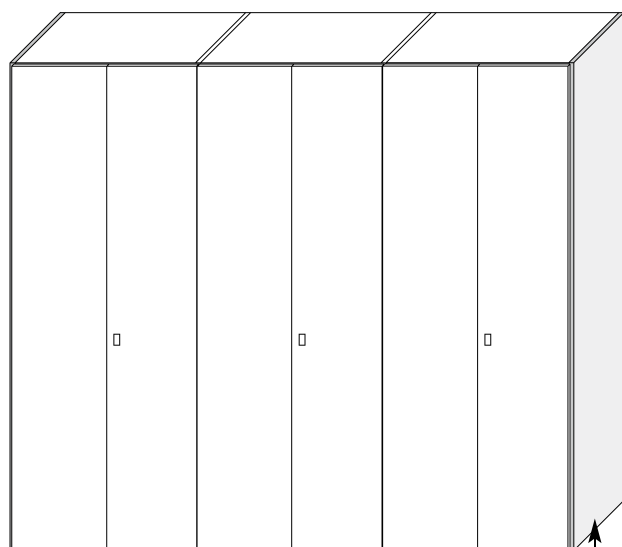
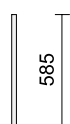

FIANCO - *SIDE PANEL*

P. - *D.* 585

Sp. - *Th.* 25

H. 2228 - 2356 - 2580 - 2900

Sp. - *Th.* 22 solo per finitura Olmo - *only for Olmo finish*

H. 2228 - 2356 - 2580

FIANCO PER TERMINALE - *SIDE PANEL FOR END UNIT*



Pianta - *Plan*

25/22
H



Divisione standard - *Standard partition*

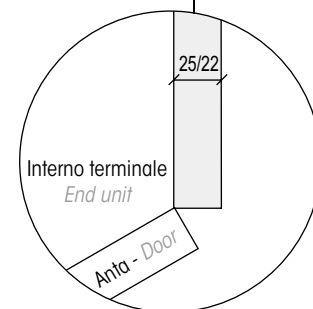
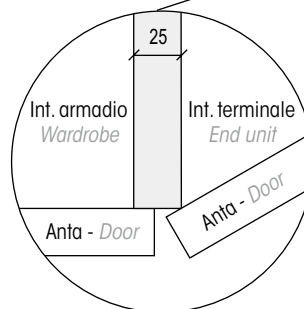
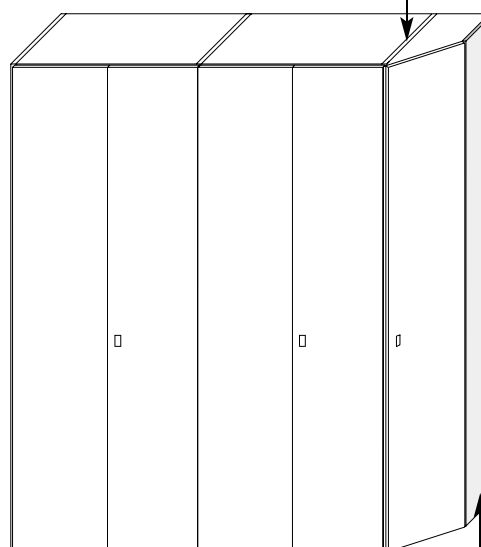

FIANCO PER TERMINALE - *SIDE PANEL FOR END UNIT*

P. - *D.* 337

Sp. - *Th.* 25

H. 2228 - 2356 - 2580 - 2900

Sp. - *Th.* 22 solo per finitura Olmo - *only for Olmo finish*

H. 2228 - 2356 - 2580

BATTENTE | *REGULAR DOOR*

utilizzo divisioni | *employ of partitions*

DIVISIONE - *PARTITION*



Pianta - *Plan*

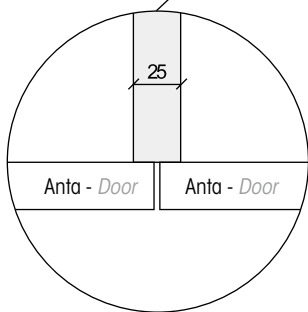
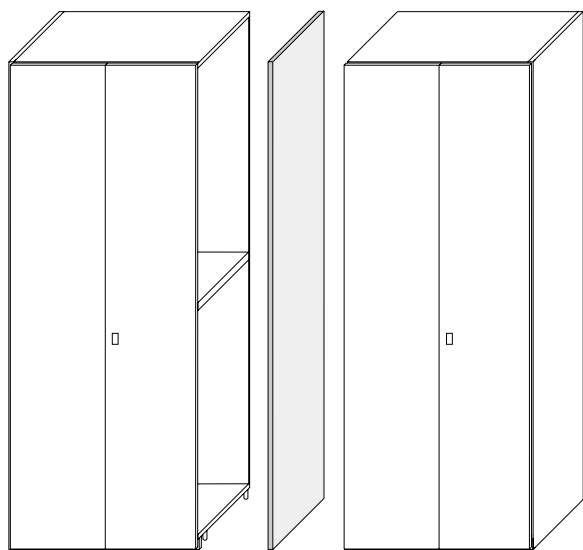

DIVISIONE - *PARTITION*
P. - D. 585
Sp. - Th. 25
H. 2228 - 2356 - 2580 - 2900

DIVISIONE SPECIALE - *SPECIAL PARTITION*



Pianta - *Plan*

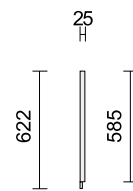

Divisione standard - *Standard partition*



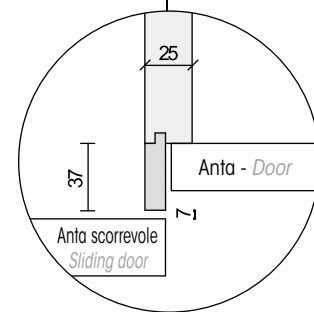
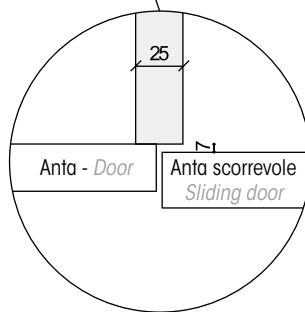
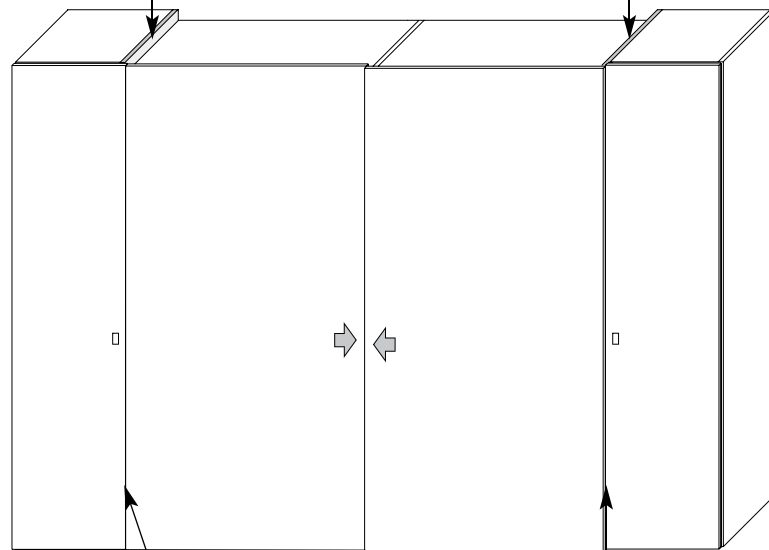



Divisione speciale - *Special partition*



DIVISIONE SPECIALE tra battente e scorrevole
SPECIAL PARTITION between regular and sliding door
P. - D. 622
Sp. - Th. 25
H. 2228 - 2356 - 2580

BATTENTE | REGULAR DOOR



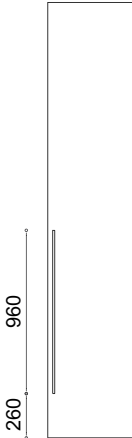
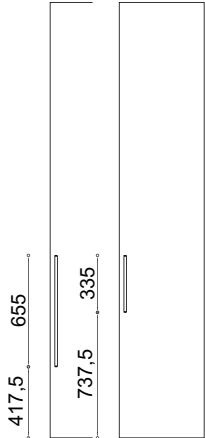
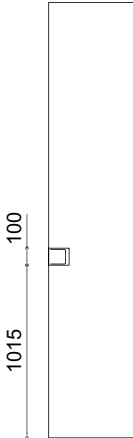
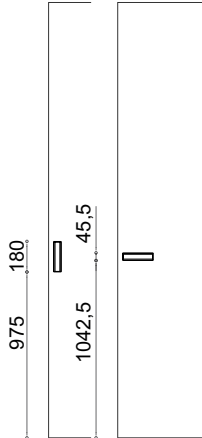
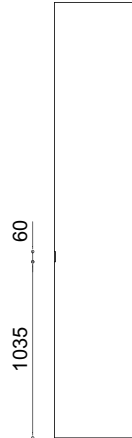
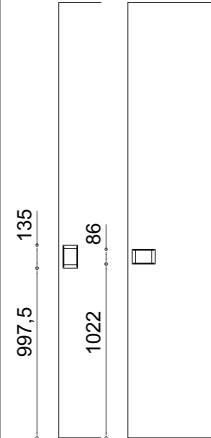



maniglie | handles

	ALFA	BETA	DAMA	ELEGANCE	GAMMA	MONITOR
						
FINITURE <i>FINISHES</i>	Nichel satinato <i>Satin nickel</i>	Nichel satinato <i>Satin nickel</i>	Essenza - Wood Laccato opaco ** <i>Matt lacquer **</i>	Brunito - Burnished Bianco - White	Cromo <i>Chrome</i>	Brunito - Burnished Bianco - White
LUNGHEZZA E POSIZIONAMENTO <i>LENGTH AND</i> <i>POSITIONING</i>	L. 960 	L. 655 - 335 	120 x 100 	180 x 45,5 	L. 65 	135 x 86 
UTILIZZABILE NELL'ANTA <i>TO BE USED WITH DOOR</i>						
BASIC	●	●		●		●
YOUNG	●	●	●	●	●	●
SIMPLY	●	●	●	●	●	●
SIMPLY VETRO					●	
SPRINT	●	●		●	●	●
CUOIO	●	●				
PREZZO <i>PRICE</i>	40	L. 655 31 L. 335 23	68	40	20	54

** disponibile in tutta la gamma colori - available in all the colour range

BATTENTE | REGULAR DOOR

maniglie | handles

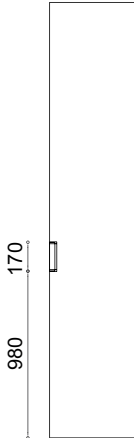
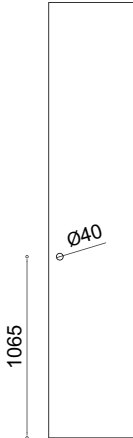
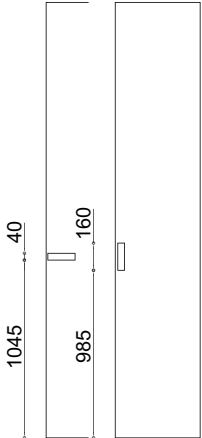
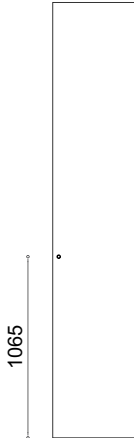
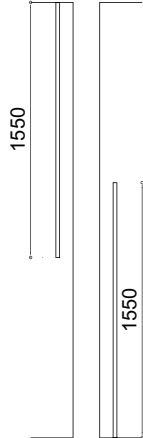
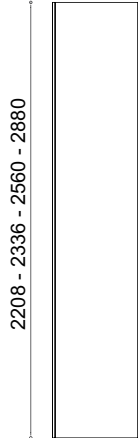
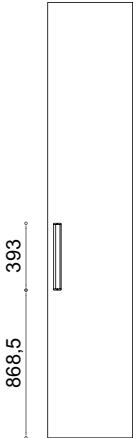
OMEGA	POMOLO	RETTA	serratura con chiave lock with key	T	TOTAL	VIP
						
Laccato opaco ** Matt lacquer **	Brunito - Burnished Bianco - White Ottone - Brass	Essenza - Wood Lacc. opaco e lucido ** Matt - glossy lacquer ** Superfici UP UP surface	Finitura nera Black finish	Brunito - Burnished Bianco - White Ottone - Brass	Brunito - Burnished Bianco - White	Laccato opaco ** Matt lacquer **
170 x 42	Ø 40	160 x 40	L. 28	L. 1550	L. 2208 - 2336 L. 2560 - 2880	393 x 44
						
	●	●		●		●
●	●	●	●	●	●	●
●	●	●	●	●	●	●
●	●	●		●	●	●
	●	●		●	●	
48	14	38	50	66	L. 2208 33 L. 2336 35 L. 2560 37 L. 2880 40	48

** disponibile in tutta la gamma colori - available in all the colour range

BATTENTE | REGULAR DOOR

tipologia di ante | door type

BASIC SP. 22 mm - TH. 22 mm

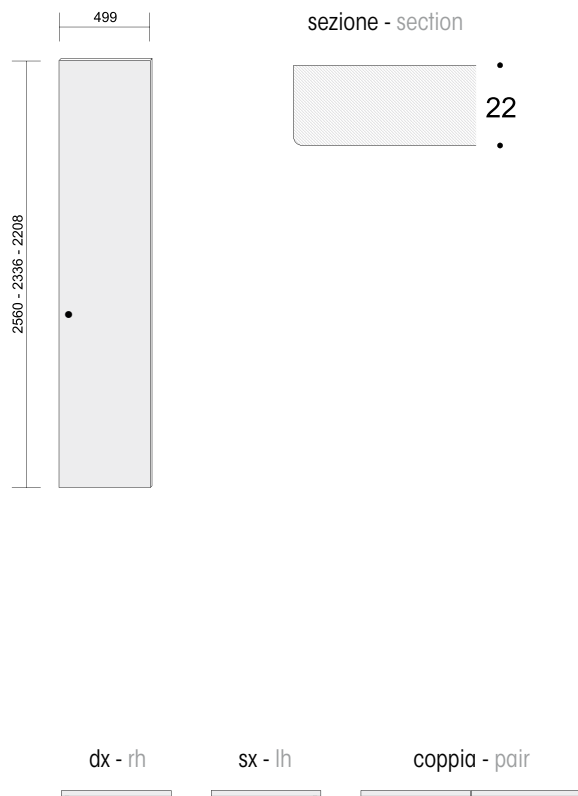

FINITURE - FINISHES

- superficie termoformata opaco bianco - *thermoformed surface, white matt*
- superficie termoformata laccata opaca - *thermoformed surface, matt lacquer ***

CARATTERISTICHE TECNICHE - TECHNICAL CHARACTERISTICS

Pannello di particelle di legno di media densità con certificazione EPA-TSCA-CARB P2 a basse emissioni di formaldeide sp. 22 mm rivestito in una lamina termoformata finitura opaca.

Wooden medium density particle board EPA-TSCA-CARB P2 certified panel with low formaldehyde emission, thick. 22 mm laminated with a thermoformed sheet, white finish.

MANIGLIE UTILIZZABILI - HANDLES AVAILABLE

- Alfa
- Beta
- Elegance
- Monitor
- Pomolo
- Retta
- T
- Vip

MODULARITÀ PREVISTA - PROVIDED MODULARITY

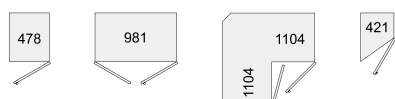

LINEAR SP. 22 mm - TH. 22 mm

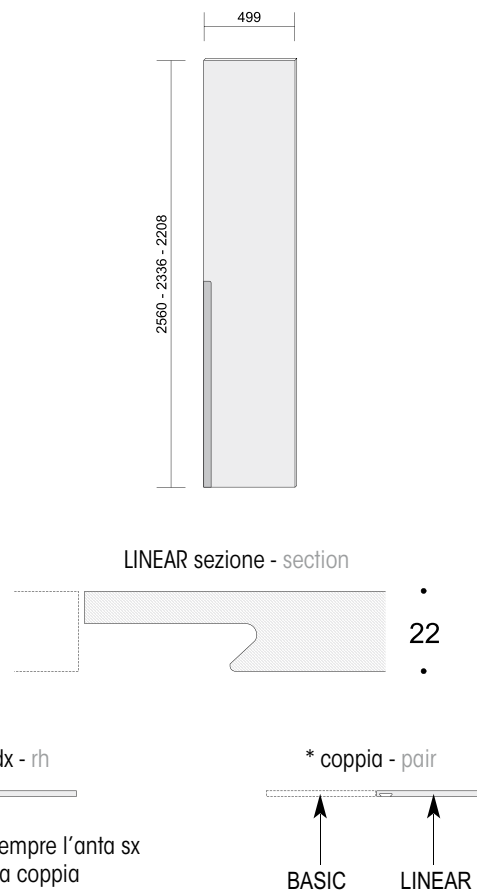

- * Utilizzare sempre l'anta sx BASIC per la coppia
- * Always use the BASIC lh door for the pair

FINITURE - FINISHES

- superficie termoformata opaco bianco - *thermoformed surface, white matt*
- superficie termoformata laccata opaca - *thermoformed surface, matt lacquer ***

CARATTERISTICHE TECNICHE - TECHNICAL CHARACTERISTICS

Pannello di particelle di legno di media densità con certificazione EPA-TSCA-CARB P2 a basse emissioni di formaldeide sp. 22 mm rivestito in una lamina termoformata finitura opaca.

Wooden medium density particle board EPA-TSCA-CARB P2 certified panel with low formaldehyde emission, thick. 22 mm laminated with a thermoformed sheet, white finish.

MANIGLIE UTILIZZABILI - HANDLES AVAILABLE

MODULARITÀ PREVISTA - PROVIDED MODULARITY



** disponibile in tutta la gamma colori - available in all the colour range

BATTENTE | REGULAR DOOR

tipologia di ante | door type

SPRINT SP. 22 mm - TH. 22 mm

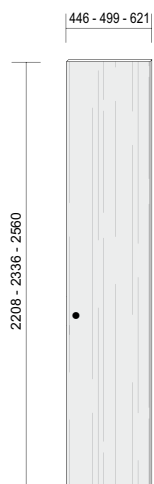

sezione - section



dx - rh sx - lh coppia - pair

FINITURE - FINISHES

- olmo con colori: bianco extra, beige
- Elm in the following colours: extra white, beige

CARATTERISTICHE TECNICHE - TECHNICAL CHARACTERISTICS

Pannello di particelle di legno con certificazione EPA-TSCA-CARB P2 a basse emissioni di formaldeide sp. 22 mm nobilitato con carta melaminica effetto olmo.

Wooden particle board EPA-TSCA-CARB P2 certified panel with low formaldehyde emission, thick. 22 mm laminated in elm melamine finish.

MANIGLIE UTILIZZABILI - HANDLES AVAILABLE

- Alfa - Beta - Elegance - Gamma - Monitor - Omega - Pomolo - Retta
- T - Total - Vip

MODULARITÀ PREVISTA - PROVIDED MODULARITY

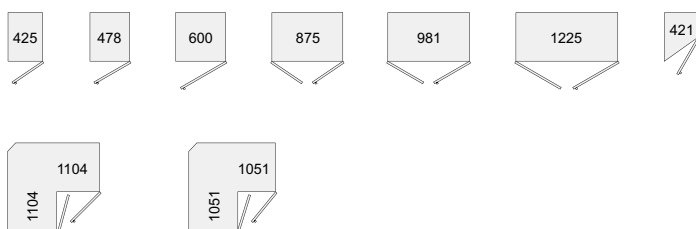

SPRINT PLUS SP. 22 mm - TH. 22 mm

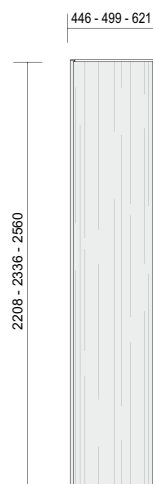

sezione - section

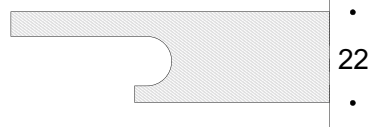

dx - rh sx - lh coppia - pair

- * Utilizzare sempre l'anta sx SPRINT per per la coppia
- * Always use the SPRINT lh door for the pair

↑ SPRINT ↑ SPRINT PLUS

FINITURE - FINISHES

- olmo con colori: bianco extra, beige
- Elm in the following colours: extra white, beige

CARATTERISTICHE TECNICHE - TECHNICAL CHARACTERISTICS

Pannello di particelle di legno con certificazione EPA-TSCA-CARB P2 a basse emissioni di formaldeide sp. 22 mm nobilitato con carta melaminica effetto olmo.

Wooden particle board EPA-TSCA-CARB P2 certified panel with low formaldehyde emission, thick. 22 mm laminated in elm melamine finish.

MODULARITÀ PREVISTA - PROVIDED MODULARITY

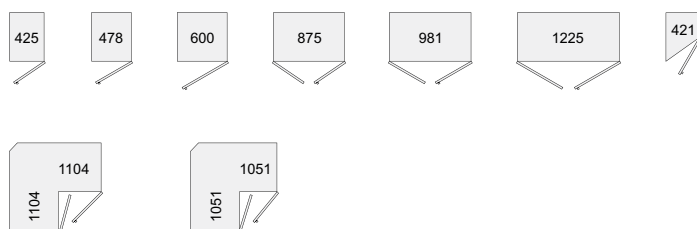

BATTENTE | REGULAR DOOR

tipologia di ante | door type

YOUNG SP. 25 - TH. 25

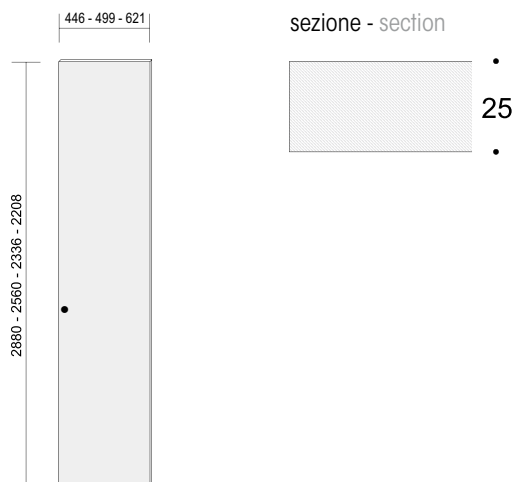

FINITURE MATERICO COLORE - COLOUR TEXTURED FINISHES

- materico colore bianco luna | *bianco luna colour textured finish*
- materico colore canapa | *canapa colour textured finish*
- materico colore grigio | *grigio colour textured finish*

FINITURE MATERICO LACCATO OPACO - MATT LACQUER TEXTURED FINISHES

- 9003 bianco
- Y20259 canapa
- 7039 grigio aston

CARATTERISTICHE TECNICHE - TECHNICAL CHARACTERISTICS

Pannello di particelle di legno con certificazione EPA-TSCA-CARB P2 a basse emissioni di formaldeide sp. 25 mm, nobilitato carta melaminica finitura materico colore bianco luna, canapa e grigio, oppure laccato opaco bianco, canapa e grigio aston.

Wooden particle board EPA-TSCA-CARB P2 certified panel with low formaldehyde emission, thick. 25 mm laminated melamine in textured colour bianco luna, canapa and grigio, or in bianco, canapa and grigio aston matt lacquer.

MANIGLIE UTILIZZABILI - HANDLES AVAILABLE

- Alfa - Beta - Dama - Elegance - Gamma - Monitor - Omega - Pomolo - Retta - T
- Total - Vip
- Serratura con chiave - *Lock with key*

MODULARITÀ PREVISTA - PROVIDED MODULARITY

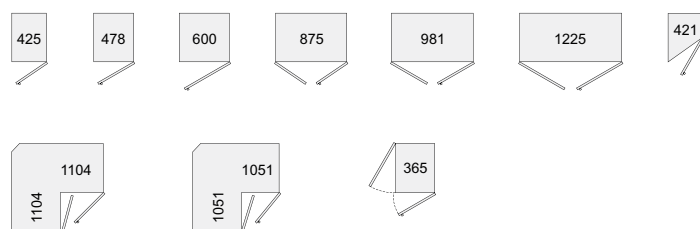

CUOIO SP. 22 - TH. 22



FINITURE ESTERNE - OUTSIDE FINISHES

- Cuoio con colori: marrone scuro, corda, bianco, nero
- *Hard leather in the following finishes: dark brown, corda, bianco, nero*

FINITURE INTERNE - INSIDE FINISHES

- Materico garzato alpaca, pino lagos, rovere termotrattato oppure laccato opaco con colori abbinati al cuoio.
- *Textured garzato alpaca, pino lagos, heat-treated oak or matching matt lacquer.*

CARATTERISTICHE TECNICHE - TECHNICAL CHARACTERISTICS

Pannello di particelle di legno con certificazione EPA-TSCA-CARB P2 a basse emissioni di formaldeide sp. 20 mm, nobilitato con carta melaminica finitura garzato alpaca, pino lagos, rovere termotrattato oppure laccato opaco con colori abbinati al cuoio nella parte interna; rivestito in cuoio rigenerato sp. 2 mm con cuciture verticali tono su tono nella parte esterna.

Wooden particle board EPA-TSCA-CARB P2 certified panel with low formaldehyde emission, thick. 20 mm laminated melamine in textured garzato alpaca, pino lagos or heat-treated oak or matching matt lacquer on the inner surface; covered with regenerated hard leather th. 2 mm, vertical stitching in matching colour on the external surface.

MANIGLIE UTILIZZABILI - HANDLES AVAILABLE

- Alfa - Beta - Pomolo - Retta - T - Total

MODULARITÀ PREVISTA - PROVIDED MODULARITY



BATTENTE | REGULAR DOOR

tipologia di ante | door type

SIMPLY SP. 25 mm - TH. 25 mm



sezione - section



dx - rh

sx - lh

coppia - pair

FINITURE - FINISHES

- laccato opaco, lucido e superfici UP - *mat and glossy lacquer, UP surface* **
- essenze | *woods cat. 1 - cat. 2*

CARATTERISTICHE TECNICHE - TECHNICAL CHARACTERISTICS

Pannello di particelle di legno con certificazione EPA-TSCA-CARB P2 a basse emissioni di formaldeide sp. 25 mm impiallacciato rovere nelle varie finiture oppure nobilitato con carta melaminica per i laccati opachi, lucidi e superfici UP.

Wooden particle board EPA-TSCA-CARB P2 certified panel with low formaldehyde emission, thick. 25 mm wood veneered oak in several finishes or laminated melamine for matt-glossy lacquers and Up surfaces.

MANIGLIE UTILIZZABILI - HANDLES AVAILABLE

- Alfa - Beta - Dama - Elegance - Gamma - Monitor - Omega - Pomolo - Retta - T
- Total - Vip
- Serratura con chiave - *Lock with key*

MODULARITÀ PREVISTA - PROVIDED MODULARITY

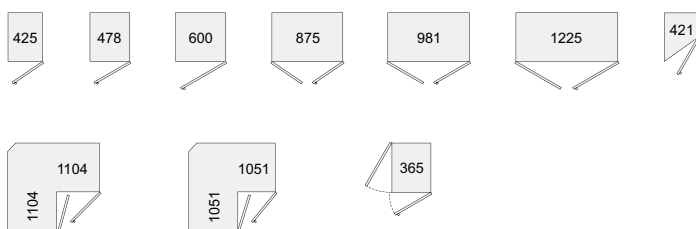

SIMPLY VETRO SP. 25 mm - TH. 25 mm

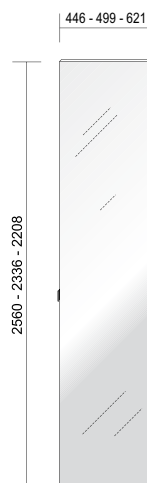

sezione - section

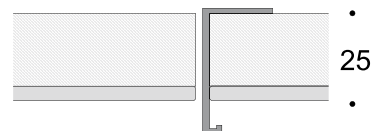

dx - rh

sx - lh

coppia - pair

FINITURE ESTERNE - OUTSIDE FINISHES

- vetro laccato o specchio - *lacquered glass or mirror* **

FINITURE INTERNE - INSIDE FINISHES

- laccato opaco - *matt lacquer* **

CARATTERISTICHE TECNICHE - TECHNICAL CHARACTERISTICS

Pannello di particelle di legno con certificazione EPA-TSCA-CARB P2 a basse emissioni di formaldeide sp. 20 mm nobilitato con carta melaminica e laccato opaco. Vetro o specchio sp. 4 mm.

Wooden particle board EPA-TSCA-CARB P2 certified panel with low formaldehyde emission, thick. 20 mm laminated melamine and matt lacquer. Glass or mirror th. 4 mm.

MANIGLIE UTILIZZABILI - HANDLES AVAILABLE

- Gamma

MODULARITÀ PREVISTA - PROVIDED MODULARITY

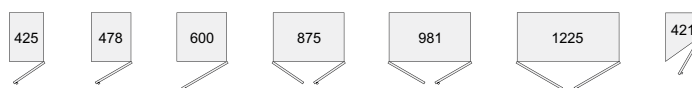

** disponibile in tutta la gamma colori - *available in all the colour range*

BATTENTE | REGULAR DOOR

tipologia di ante | door type

TECNO SP. 25 mm - TH. 25 mm

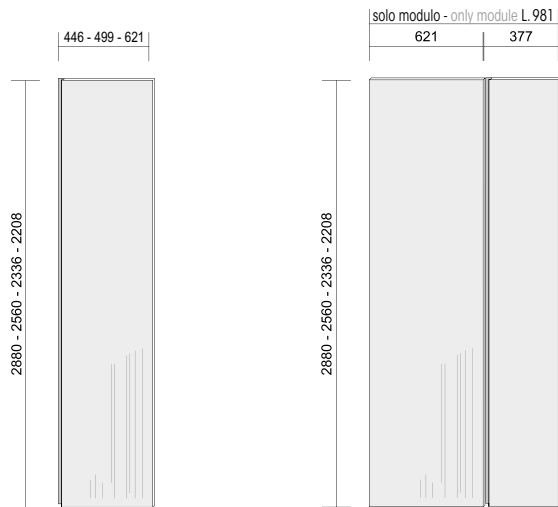

sezione - section



dx - rh

sx - lh

coppia - pair

* Utilizzare sempre l'anta sx SIMPLY per la coppia

* Always use the SIMPLY lh door for the pair

SIMPLY TECNO

FINITURE - FINISHES

- laccato opaco, lucido e superfici UP - *mat and glossy lacquer, UP surface* **
- essenze | *woods cat. 1 - cat. 2*

CARATTERISTICHE TECNICHE - TECHNICAL CHARACTERISTICS

Pannello di particelle di legno con certificazione EPA-TSCA-CARB P2 a basse emissioni di formaldeide sp. 25 mm impiallacciato rovere nelle varie finiture oppure nobilitato con carta melaminica per i laccati opachi, lucidi e superfici UP.

Wooden particle board EPA-TSCA-CARB P2 certified panel with low formaldehyde emission, thick. 25 mm wood veneered oak in several finishes or laminated melamine for matt-glossy lacquers and Up surfaces.

MANIGLIA - HANDLE

Inserita per tutta la lunghezza dell'anta, disponibile in finitura laccato opaco **
*Built-in along the length of the door, available in matt lacquer finish ***

MODULARITÀ PREVISTA - PROVIDED MODULARITY

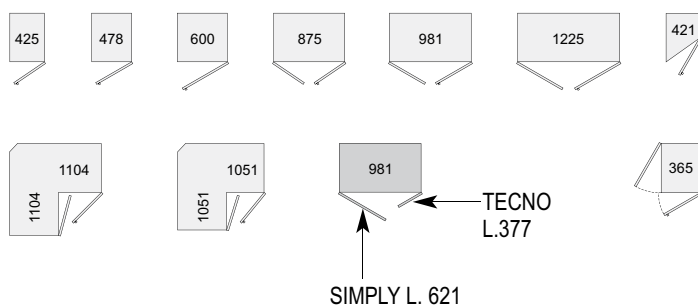

TECNO VETRO SP. 25 mm - TH. 25 mm

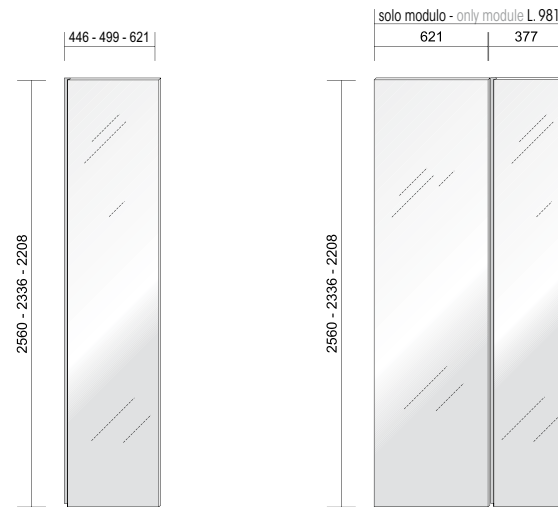

sezione - section

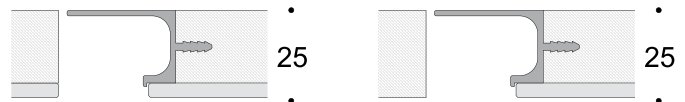

dx - rh

sx - lh

coppia - pair

* Utilizzare sempre l'anta sx SIMPLY o SIMPLY VETRO per la coppia

* Always use the SIMPLY lh door or SIMPLY VETRO for the pair

SIMPLY-SIMPLY VETRO TECNO VETRO

FINITURE ESTERNE - OUTSIDE FINISHES

- vetro laccato o specchio - *lacquered glass or mirror* **

FINITURE INTERNE - INSIDE FINISHES

- laccato opaco - *matt lacquer* **

CARATTERISTICHE TECNICHE - TECHNICAL CHARACTERISTICS

Pannello di particelle di legno con certificazione EPA-TSCA-CARB P2 a basse emissioni di formaldeide sp. 20 mm nobilitato con carta melaminica e laccato opaco. Vetro o specchio sp. 4 mm.

Wooden particle board EPA-TSCA-CARB P2 certified panel with low formaldehyde emission, thick. 20 mm laminated melamine and matt lacquer. Glass or mirror th. 4 mm.

MANIGLIA - HANDLE

Inserita per tutta la lunghezza dell'anta, disponibile in finitura laccato opaco **
*Built-in along the length of the door, available in matt lacquer finish ***

MODULARITÀ PREVISTA - PROVIDED MODULARITY

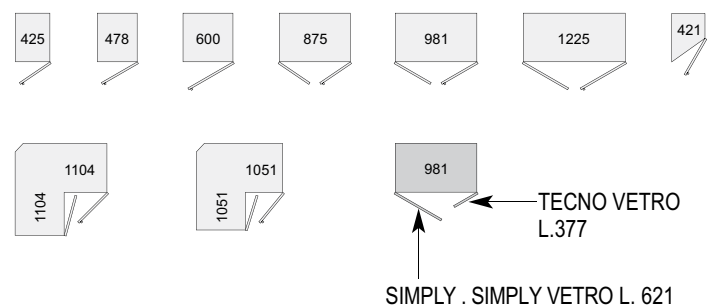

** disponibile in tutta la gamma colori - *available in all the colour range*

BATTENTE | REGULAR DOOR

tipologia di ante | door type

ARCO SP. 25 - TH. 25



dx - rh



* Utilizzare sempre l'anta sx
SIMPLY per la coppia
* Always use the SIMPLY lh door
for the pair

coppia - pair

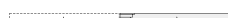

SIMPLY ARCO

FINITURE - FINISHES

- laccato opaco - *matt lacquer* **

CARATTERISTICHE TECNICHE - TECHNICAL CHARACTERISTICS

Pannello di particelle di legno a media densità con certificazione EPA-TSCA-CARB P2 a basse emissioni di formaldeide sp. 25 mm laccato opaco.

Wooden particle medium density board EPA-TSCA-CARB P2 certified panel with low formaldehyde emission, thick. 25 mm matt lacquered.

MANIGLIA: inserita nell'anta, disponibile nelle varie tinte del rovere, in noce Canaletto o laccato opaco **.

*HANDLE: built-in the door, available in the various finish of the oak, Canaletto walnut or matt lacquer colour **.*

MODULARITÀ PREVISTA - PROVIDED MODULARITY

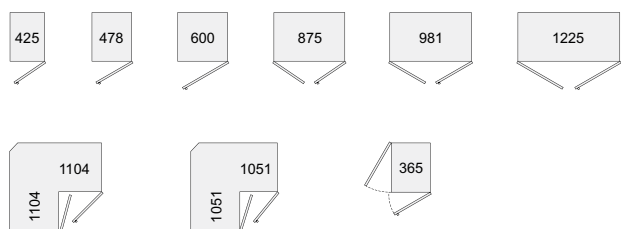

FRECCIA SP. 25 - TH. 25



dx - rh



sx - lh



coppia - pair



FRECCIA FRECCIA

FINITURE - FINISHES

- laccato opaco - *matt lacquer* **

- essenza rovere termotrattato - *heat-treated oak wood*

CARATTERISTICHE TECNICHE - TECHNICAL CHARACTERISTICS

Pannello di particelle di legno a media densità con certificazione EPA-TSCA-CARB P2 a basse emissioni di formaldeide sp. 25 mm laccato opaco o impiallacciato rovere termotrattato.

Wooden particle medium density board EPA-TSCA-CARB P2 certified panel with low formaldehyde emission, thick. 25 mm matt lacquered or veneered in heat-treated oak.

MANIGLIA: inserita nell'anta, disponibile in finitura bianco, ottone o brunito.

HANDLE: built-in the door, available in white, brass or bunished finish.

MODULARITÀ PREVISTA - PROVIDED MODULARITY

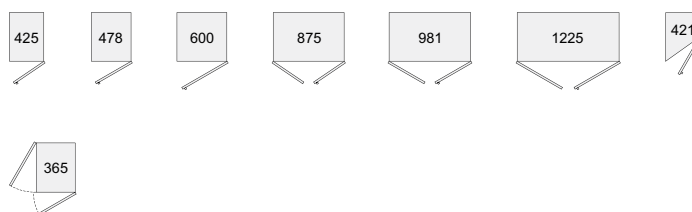

** disponibile in tutta la gamma colori - *available in all the colour range*

BATTENTE | *REGULAR DOOR*

tipologia di ante | *door type*

CONCA SP. 25 - TH. 25

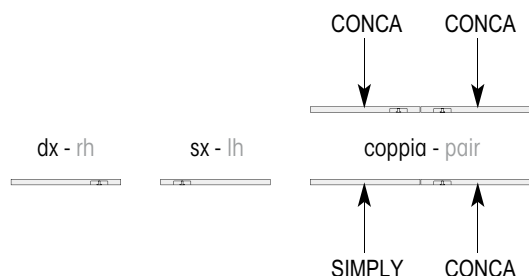
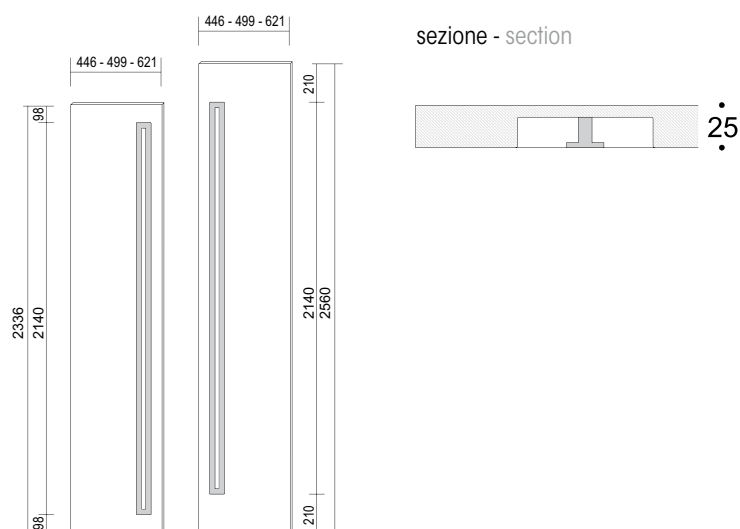

FINITURE - FINISHES

- laccato opaco - *mat lacquer* **

CARATTERISTICHE TECNICHE - TECHNICAL CHARACTERISTICS

Pannello di particelle di legno a media densità con certificazione EPA-TSCA-CARB P2 a basse emissioni di formaldeide sp. 25 mm laccato opaco.

Wooden particle medium density board EPA-TSCA-CARB P2 certified panel with low formaldehyde emission, thick. 25 mm matt lacquered.

MANIGLIA: inserita nell'anta, disponibile in finitura bianco, ottone o brunito.

HANDLE: built-in the door, available in white, brass or burnished finish.

MODULARITÀ PREVISTA - PROVIDED MODULARITY

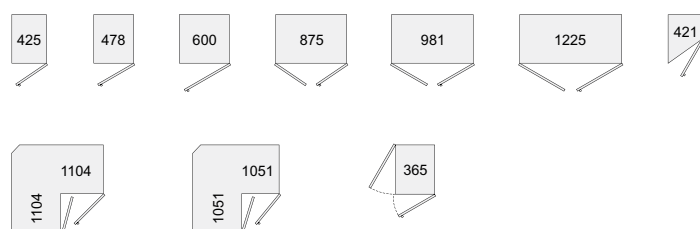

GLASS UP SP. 35 - TH. 35



FINITURE TELAIO - FRAME FINISHES

- brunito - *burnished*

FINITURE VETRO - GLASS FINISHES

- vetro trasparente - *transparent glass*

- vetro trasparente grigio - *grey transparent glass*

CARATTERISTICHE TECNICHE - TECHNICAL CHARACTERISTICS

Telaio in alluminio finitura brunita, vetro trasparente e trasparente grigio sp. 4 mm, con apertura tramite presa laterale sul telaio e chiusura ammortizzata.

Aluminium frame in burnished finish, transparent glass and transparent grey glass th. 4 mm, with side grip-handle opening and soft closure system.

MODULARITÀ PREVISTA - PROVIDED MODULARITY

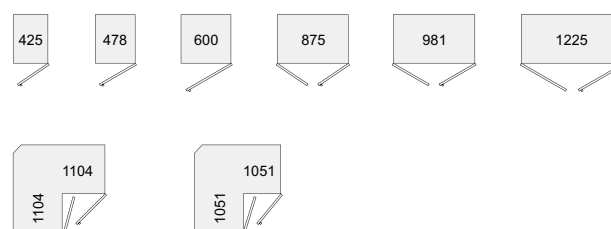

** disponibile in tutta la gamma colori - *available in all the colour range*