

GENERAL TECHNICAL INFORMATION

Transforming system with single or intermediate foldaway vertical bed with folding opening and slatted bed

Folding mechanism with visible gas springs, mounted to the structure, with devices that remain perfectly locked in both positions of use. The bed rests on metal feet, which protrude from the bed base in the opening phase.

The model is available in the Standard, Desk (desk top) and Work (table) versions.

The system can stand alone or be integrated and coordinated with the elements of the Living and Young System programs.

Telemaco Standard is available in single bed version with 850 mm wide mattress and intermediate version with 1150 mm wide mattress.

Telemaco Desk is available in the single and intermediate bed versions, featuring a desk top which, for the night configuration, is positioned horizontally under the bed base with a tilting movement, without the need to remove objects placed on it.

Telemaco Work is available in the single version, featuring a table perpendicular to the front of the unit, which, for the night version, is positioned under the bed base with a tilting movement, without the need to objects placed on it.

- Wooden **frame** with adjustable nylon feet.

- **Bed base with frame** in tubular steel frame and slats in solid beech plywood attached to the frame with nylon/rubber seals.

- weight of Telemaco 90 bed base: Kg 20 - weight of Telemaco 120 bed base: Kg 23

- weight of Telemaco 90 bed base + front panel Kg 32 - weight of Telemaco 120 bed base + front panel: Kg 38

- Standard **mattresses** H 180 mm single bed 850 mm x 1970 mm, weight 14-16 kg, intermediate bed 1150 mm x 1970 mm, weight 21-23 kg Spring, memory basic, memory - independent spring coils, 7 zone memory, deluxe memory versions. For further information on mattresses, please refer to the specific page of the price list.

- Adjustable mattress **locking belts** in nylon with black nylon release fasteners.

- **Maximum liftable weight** (including mattress, blankets and pillows): Telemaco

- Telemaco 90: kg 52 - Telemaco 120: kg 63

- **Standard finishes:**

Structure: Melamine White, Oak Sabbia, Oak Moro, Perla, Tortora and lacquered as per Cleicoloursystem.

Front: Melamine White, Oak Sabbia, Oak Moro, Perla, Tortora, Glossy White Dialux, lacquered as per Cleicoloursystem.

Back: Melamine White and lacquered as per Cleicoloursystem.

Decorations: Prints, Quadra - Petalo - Wave, fixed configurations as per chapter decorations of the pricelist.

N.B.: Made-to-measure sizes are not possible.

WARNINGS: Assembly and safety



THIS MODEL MUST BE FIXED TO THE WALL

This product is delivered disassembled and provided with specific assembly instructions.

The product must be anchored to walls using 3 anchor points and must stand on perfectly level floors.

A hardware kit is supplied for assembly, but it does not include wall plugs which, in order to guarantee safety, must be chosen by the installer based on the type of wall or partition where the product is to be installed, and which the manufacturer does not know.

The installer is responsible for workmanlike assembly and testing of the product.

For further specific warnings, please see page 15 of this price list and the instruction booklet that is supplied with each product inside the packaging.

TELEMACO 90 / 120 STANDARD

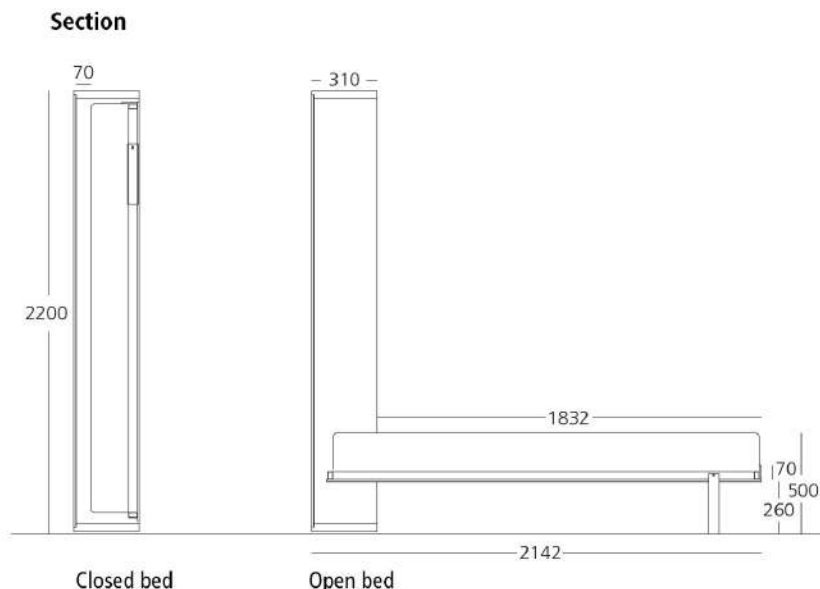
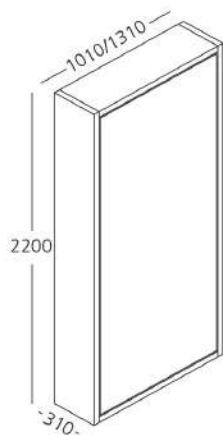

Accessories - TELEMACO

Soft padded headboard

Textile headboard mounted directly to the back panel with press-studs.
 Dacron padding, 60 mm thick.
 Dacron padding, 60 mm thick.
 Dimensions of single: W 920 mm x D 60 mm x H 640 mm
 Dimensions of intermediate W 1200 mm x D 60 mm x H 640 mm

Tight padded headboard

Fabric headboard with internal MDF support, fixed directly to the back panel with firm-grip velcro.
 Padding in foam, rear part upholstered with canvas, thickness mm 30.
 Dimensions of single: W 900 x D 30 mm x H 760 mm
 Dimensions of intermediate W 1200 x D 30 mm x H 760 mm

Section

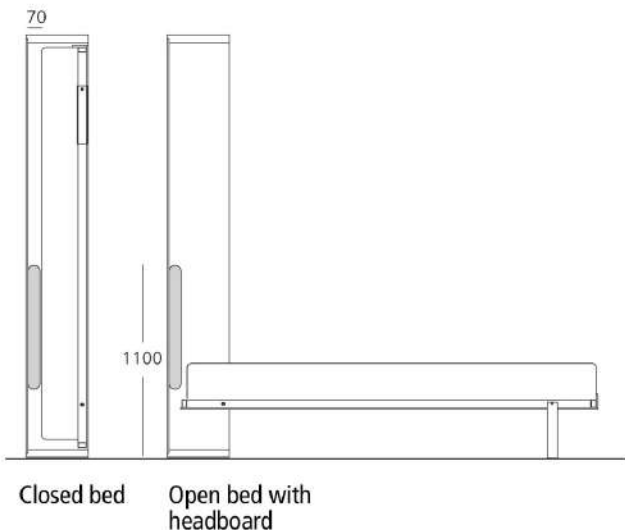

TELEMACO 90

TELEMACO 120

Soft headboard dimensions

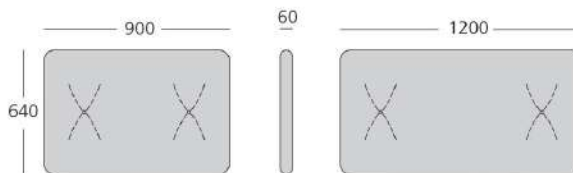

Tight headboard dimensions

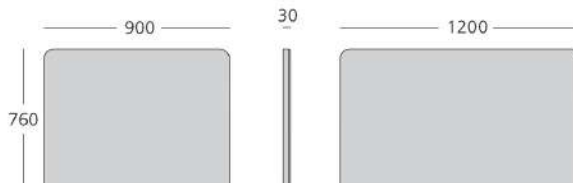

LED light

Semi-recessed warm-tone LED system made of an anodized aluminum frame, opaline polycarbonate cover and sensor switch. The LED used is certified in compliance with EN62471 regulation as part of the "risk-free" category that assures its unlimited maximum safety.

LED 3000°K 1,9 W IP40 75/80 Lm/W EEC A+



Dimensions: W 30 mm x D 9 mm x H 200 mm

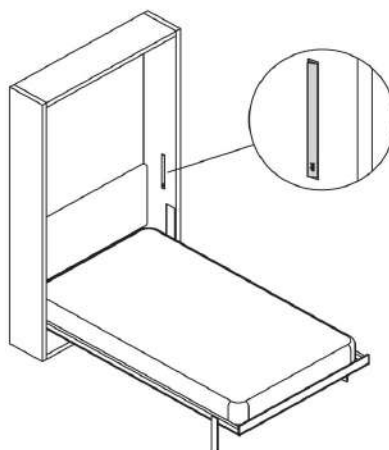

TELEMACO 90/120 DESK

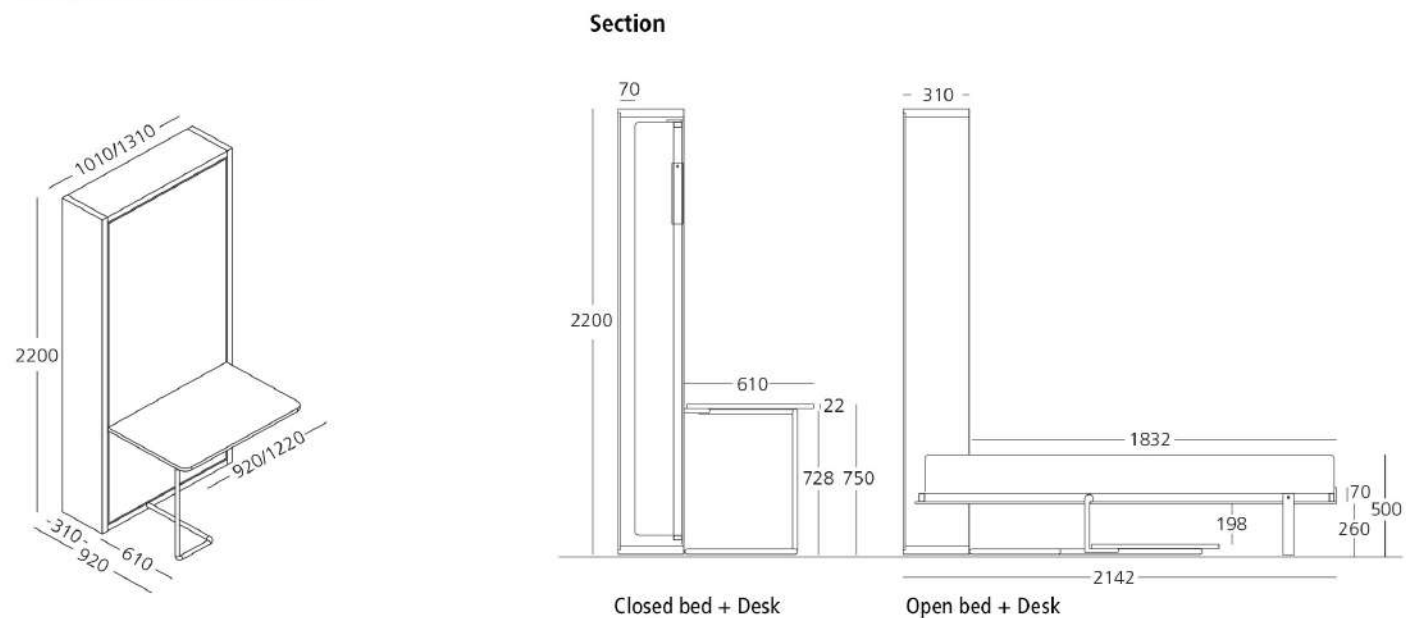

DESK TECHNICAL FEATURES

Writing desk top with opening mechanism and support connected to the bed in powder-coated tubular metal in the same color as the bed base.
 Maximum load: 35 kg equally distributed

