

vanity

design bolzan LAB



Fresca sobrietà di linee e volumi, per un letto che si trova perfettamente a suo agio negli ambienti classici come negli spazi più moderni. La testiera arrotondata si ispira alla tradizione, idealizzandola in un segno grafico pieno e accogliente. La trasversalità del progetto viene ulteriormente enfatizzata dalla possibilità di scegliere la base con contenitore.

Fresh sobriety of lines and volumes, for a bed that is perfect in classic environments as well as in more modern spaces. The rounded headboard is inspired by tradition, idealizing it in a full and welcoming graphic sign. The transversality of the project is further emphasized by the possibility of choosing the base with storage box.

informazioni tecniche / technical info:

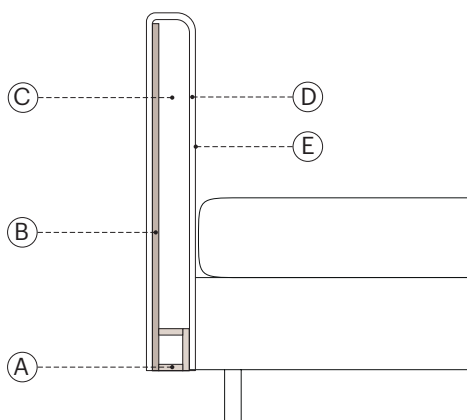

h 20

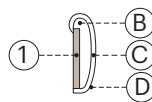

h 29

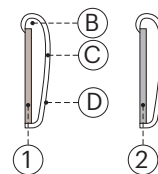

testata / headboard

- A. listellare di abete 3 strati 22mm / 22mm 3-layer fir blockboard
- B. truciolare 18 mm / 18 mm multilayer
- C. espanso ignifugo D 30 kg/mc / fire resistant foam D 30 kg/mc
- D. resinato poliestere ignifugo 100g / 100g fire retardant resin polyester fiber
- E. maglia polipropilene 70g / 70g polypropylene mesh

giroletti / bedframes

- 1. listellare abete 22mm 3 strati / 22mm 3-layer fir blockboard
- 2. estruso in alluminio 22mm / 22 mm extruded aluminum
- B. espanso ignifugo D 35 kg/mc / fire resistant foam D 35 kg/mc
- C. resinato poliestere ignifugo 100g / 100g fire resistant resined polyester fiber
- D. maglia polipropilene 70g / 70g polypropylene mesh

predisposto per materassi / for mattresses:

90 x 200	35 ³ / ₈ " x 78 ⁶ / ₈ "	
100 x 200	39 ³ / ₈ " x 78 ⁶ / ₈ "	
120 x 200	47 ² / ₈ " x 78 ⁶ / ₈ "	
140 x 200	55 ¹ / ₈ " x 78 ⁶ / ₈ "	
160 x 200	63" x 78 ⁶ / ₈ "	
170 x 200	66 ⁷ / ₈ " x 78 ⁶ / ₈ "	
180 x 200	70 ⁷ / ₈ " x 78 ⁶ / ₈ "	
137 x 190	54" x 75"	F ull double size
153 x 203	60" x 80"	Q ueen size
193 x 203	76" x 80"	K ing size

personalizzazioni disponibili / available customizations:



gonnellina / skirt gonnellina / skirt
chic

Vanity / Firwood structure

Standard feet Vasetto - removable headboard cover in fabric and non removable in leather or eco-leather

	Mattress	Ext. dimension	Code	D	C	A	Plus	Luxury fabric	Luxury leather	Nuvola fabric	Nuvola leather	TCL	Cover		kg	
													ml	mc		
rounded base h.20 - rounded base h.29 without slatted base (to choose a slatted base see flap on the right)	90x200	108x218	VAS29										5.5	0.32	47	
	100x200	118x218	VAC29										6	0.33	50	
	120x200	138x218	VAD29										6.5	0.35	59	
	135x190	153x208	VAI29										6.9	0.36	62	
	137x190 DOUBLE 54X75	155x208	VAE29										6.9	0.36	62	
	140x200	158x218	VAU29										7	0.37	63	
	150x200	168x218	VAL29										7.5	0.38	68	
	153x203 QUEEN 60X80	171x221	VAQ29											7.5	0.38	68
	160x200	178x218	VAM29											8	0.39	69
	170x200	188x218	VAF29											8.3	0.4	72
	180x200	198x218	VAG29											8.5	0.42	74
	190x200	208x218	VAP29											9	0.45	80
	193x203 KING 76X80	211x221	VAK29											9	0.45	80
		Loose cover		RVA											0.02	8
rounded base h.20 - rounded base h.29 w/BOX orthopaedic slatted base included suggested weights for mattresses (see flap on the right)	90x200	108x218	VAS29B										5.5	0.45	87	
	100x200	118x218	VAC29B										6	0.48	96	
	120x200	138x218	VAD29B										6.5	0.53	110	
	135x190	153x208	VAI29B										6.9	0.58	115	
	137x190 DOUBLE 54X75	155x208	VAE29B										6.9	0.58	115	
	140x200	158x218	VAU29B										7	0.59	116	
	150x200	168x218	VAL29B										7.5	0.63	122	
	153x203 QUEEN 60X80	171x221	VAQ29B											7.5	0.63	122
	160x200	178x218	VAM29B											8	0.64	124
	170x200	188x218	VAF29B											8.3	0.67	130
	180x200	198x218	VAG29B											8.5	0.69	136
	190x200	208x218	VAP29B											9	0.72	144
	193x203 KING 76X80	211x221	VAK29B											9	0.72	144
	available inside height in Box 12-18cm	Loose cover		RVA											0.02	8
rounded base h.20 - rounded base h.29 w/easy-up BOX orthopaedic slatted base included suggested weights for mattresses (see flap on the right)	90x200	108x218	VAS29BE										5.5	0.49	97	
	100x200	118x218	VAC29BE										6	0.52	106	
	120x200	138x218	VAD29BE										6.5	0.57	120	
	135x190	153x208	VAI29BE										6.9	0.62	125	
	137x190 DOUBLE 54X75	155x208	VAE29BE										6.9	0.62	125	
	140x200	158x218	VAU29BE										7	0.63	126	
	150x200	168x218	VAL29BE										7.5	0.67	132	
	153x203 QUEEN 60X80	171x221	VAQ29BE											7.5	0.67	132
	160x200	178x218	VAM29BE											8	0.68	134
	170x200	188x218	VAF29BE											8.3	0.71	140
	180x200	198x218	VAG29BE											8.5	0.73	146
	190x200	208x218	VAP29BE											9	0.76	154
	193x203 KING 76X80	211x221	VAK29BE											9	0.76	154
	available inside height in Box 12-18cm	Loose cover		RVA											0.02	8

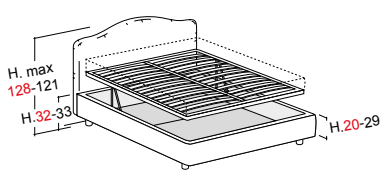
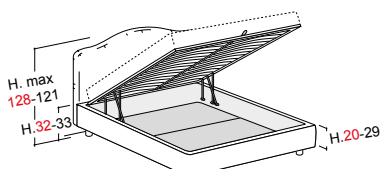
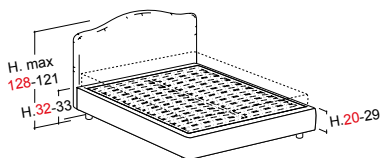

Vanity / Aluminum structure

Standard feet Vasetto - removable headboard cover in fabric and non removable in leather or eco-leather

	Mattress	Ext. dimension	Code	D	C	A	Plus	Luxury fabric	Luxury leather	Nuvola fabric	Nuvola leather	TCL	Cover			
													ml	mc	kg	
rounded base h.29 without slatted base (to choose a slatted base see flap on the right)	90x200	108x218	VAS29A										5.5	0.32	43	
	100x200	118x218	VAC29A										6	0.33	46	
	120x200	138x218	VAD29A										6.5	0.35	52	
	135x190	153x208	VAI29A										6.9	0.36	56	
	137x190 DOUBLE 54X75"	155x208	VAE29A										6.9	0.36	56	
	140x200	158x218	VAU29A										7	0.37	57	
	150x200	168x218	VAL29A										7.5	0.38	61	
	153x203 QUEEN 60X80"	171x221	VAQ29A										7.5	0.38	61	
	160x200	178x218	VAM29A										8	0.39	62	
	170x200	188x218	VAF29A										8.3	0.4	65	
	180x200	198x218	VAG29A										8.5	0.42	71	
	190x200	208x218	VAP29A										9	0.45	77	
	193x203 KING 76X80"	211x221	VAK29A										9	0.45	77	
		Loose cover		RVAA											0.02	8
	rounded base h.29 w/box orthopaedic slatted base included suggested weights for mattresses (see flap on the right)	90x200	108x218	VAS29BA										5.5	0.45	88
100x200		118x218	VAC29BA										6	0.48	97	
120x200		138x218	VAD29BA										6.5	0.53	111	
135x190		153x208	VAI29BA										6.9	0.58	117	
137x190 DOUBLE 54X75"		155x208	VAE29BA										6.9	0.58	117	
140x200		158x218	VAU29BA										7	0.59	118	
150x200		168x218	VAL29BA										7.5	0.63	125	
153x203 QUEEN 60X80"		171x221	VAQ29BA										7.5	0.63	125	
160x200		178x218	VAM29BA										8	0.64	127	
170x200		188x218	VAF29BA										8.3	0.67	133	
180x200		198x218	VAG29BA										8.5	0.69	141	
190x200		208x218	VAP29BA										9	0.72	149	
193x203 KING 76X80"		211x221	VAK29BA										9	0.72	149	
		Loose cover		RVAA											0.02	8
rounded base h.29 w/easy-up box orthopaedic slatted base included suggested weights for mattresses (see flap on the right)		90x200	108x218	VAS29BEA										5.5	0.49	98
	100x200	118x218	VAC29BEA										6	0.52	107	
	120x200	138x218	VAD29BEA										6.5	0.57	122	
	135x190	153x208	VAI29BEA										6.9	0.62	127	
	137x190 DOUBLE 54X75"	155x208	VAE29BEA										6.9	0.62	127	
	140x200	158x218	VAU29BEA										7	0.63	129	
	150x200	168x218	VAL29BEA										7.5	0.67	135	
	153x203 QUEEN 60X80"	171x221	VAQ29BEA										7.5	0.67	135	
	160x200	178x218	VAM29BEA										8	0.68	137	
	170x200	188x218	VAF29BEA										8.3	0.71	143	
	180x200	198x218	VAG29BEA										8.5	0.73	151	
	190x200	208x218	VAP29BEA										9	0.76	159	
	193x203 KING 76X80"	211x221	VAK29BEA										9	0.76	159	
		Loose cover		RVAA											0.02	8
	rounded base h.29 w/HANDS FREE BOX orthopaedic slatted base included Specify mattress weight (see flap on the right)	150x200	168x221	VAL29BHF										7.5	0.67	131
153x203 QUEEN 60X80"		171x224	VAQ29BHF										7.5	0.67	131	
160x200		178x221	VAM29BHF										8	0.68	133	
170x200		188x221	VAF29BHF										8.3	0.71	135	
180x200		198x221	VAG29BHF										8.5	0.73	141	
190x200		208x221	VAP29BHF										9	0.76	148	
193x203 KING 76X80"		211x224	VAK29BHF										9	0.76	148	
		Loose cover		RVAHF											0.02	157

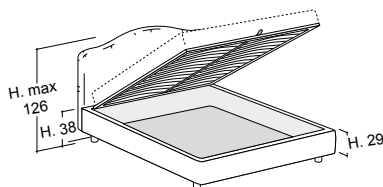
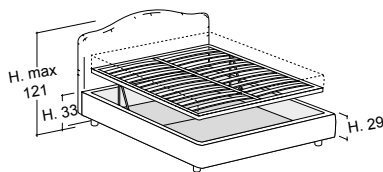
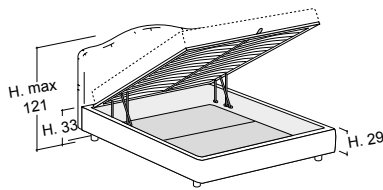
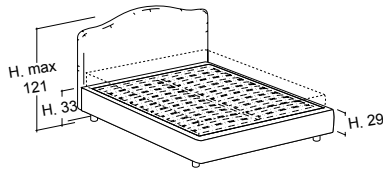

GIROLETTI E PIEDINI / BEDFRAMES AND FEET

bedframe h.9 cm



cilindro
H 26 cm 10²/₈"



vasetto
H 26 cm 10²/₈"



vasetto inclinato
H 26 cm 10²/₈"



tubino
H 26 cm 10²/₈"



lamina
H 26 cm 10²/₈"



arco
H 26 cm 10²/₈"

bedframe h.20 cm



cilindro
H 12,5 cm 4⁷/₈"



vasetto
H 12,5 cm 4⁷/₈"



tubino
H 12,5 cm 4⁷/₈"



lamina
H 15 cm 5⁷/₈"

bedframe h.29 cm



vasetto h. 4cm
H 4 cm 1⁵/₈"



vasetto h. 9-12,5 cm
H 9 cm 3⁴/₈"
H 12,5 cm 4⁷/₈"



cipolla
H 8 cm 3¹/₈"

pedini in legno / wooden feet:

pedini realizzati in legno di pino con possibilità di essere tinti, verniciati ral o foderati in tessuto a scelta.

pedini realizzati in legno di pino con possibilità di essere tinti, verniciati ral o foderati in tessuto a scelta.

finiture legno tinto / lacquered wood finishes:



noce / walnut



ciliegio / cherry



rovere / oak



wengè

pedini in metallo / metal feet:

pedini realizzati in acciaio con possibilità di essere verniciati effetto ottone o colori ral.

pedini realizzati in acciaio con possibilità di essere verniciati effetto ottone o colori ral.

finiture metallo / metal finishes:



ottone satinato /
brushed brass

finiture laccati ral / ral lacquered finishes:



bianco / white
RAL 9010



perla / pearl
RAL 1013



nero / black
RAL 9011



grigio / grey
RAL 7044



marrone / brown
RAL 8019



rosso / red
RAL 3005



verde / green
RAL 6020



blu / blue
RAL 5008

h. 20-29 SISTEMA CONTENITORE / BOX SYSTEM



box

BOX

apertura basic del box grazie ad un semplice sistema a leva / basic opening of storage box thanks to a simple lever system

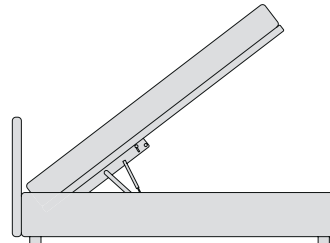

interno in legno



interno in alluminio

HANDS-FREE

apertura del box senza l'uso delle mani e grazie al box completamente in alluminio è privo di pistoncini a vista / The mechanism allows to open the storage box without hands, and thanks to its aluminum structure, the storage box has inner pistons, thus maintaining a top-notch design

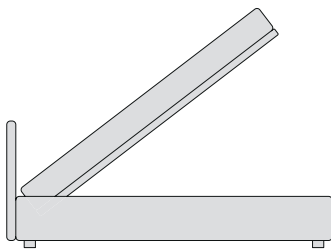

interno in alluminio

EASY UP

grazie al movimento che mantiene la rete all'interno dello spazio occupato dal letto, ottimizza lo spazio all'interno della stanza / mechanism optimizes the space inside the room thanks to its movement that keeps the slatted base within the space occupied by the bed

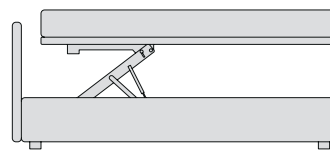

interno in legno



interno in alluminio

h. 20-29 INCASSO MATERASSO / MATTRESS RECESS

La struttura dei letti Bolzan permette di soddisfare le diverse esigenze di progettazione: l'incasso del materasso nella struttura del letto è personalizzabile in 7 altezze diverse. Non disponibile per le basi con box.

Bolzan beds' structure allows you to meet different design needs: the mattress recess in the bed's structure is customizable in 7 different heights. It is not available for bases with box.

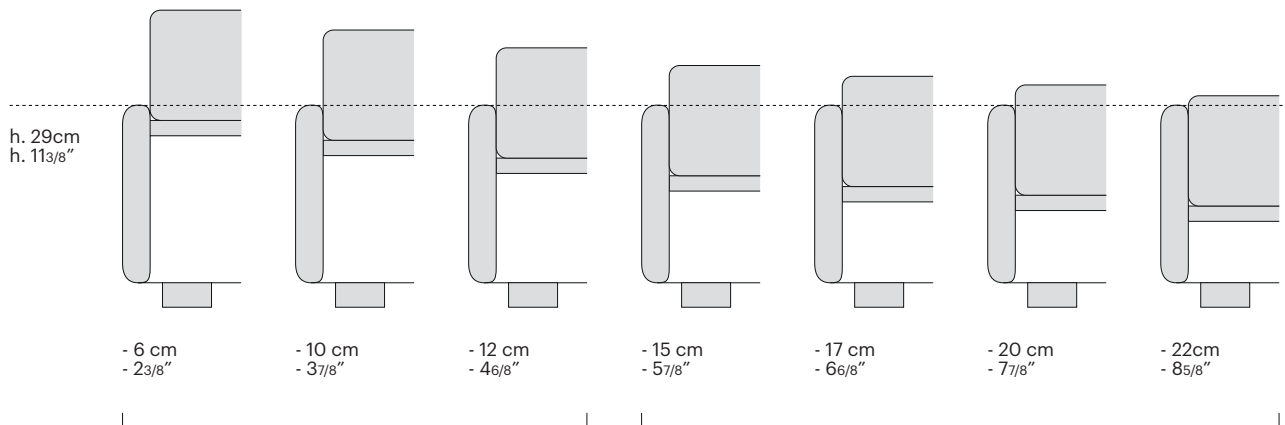

ribassamento disponibile per giroletto h. 20 e h. 29 cm / mattress recess available for h. 20 and h. 29 cm bedframes

ribassamento disponibile solo per giroletto h. 29 cm / mattress recess available for h. 29 cm bedframe