

karol

design bolzan LAB



Un design senza tempo per un letto capace di armonizzarsi con ogni spazio, ambiente e stile di vita. Una semplicità che nasce da un'approfondita ricerca stilistica, espressa attraverso linee e volumi disegnati senza incertezze. Karol si presta a situazioni sontuose o informali, con la stessa spontanea eleganza.

A design without time for a bed able to harmonize itself with every space, atmosphere and style of life. A simplicity born from a deep stylistic research, expressed through lines and volumes designed without uncertainties. Karol is perfect both for luxurious and casual situations, with its same spontaneous elegance.

informazioni tecniche / technical info:

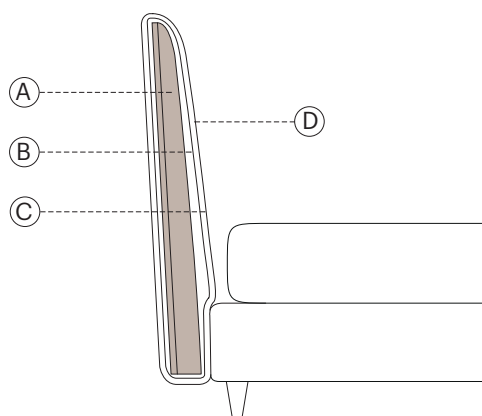

testata / headboard

- A. telaio interno centinato in multistrato pioppo 18mm e listellare di abete 3 strati 22mm / inner curved frame in 18mm poplar multilayer and 22mm 3-layer fir blockboard
- B. espanso ignifugo D 25 kg/mc / fire retardant foam D. 25 kg/mc
- C. resinato poliestere ignifugo 100g / 100g fire resistant resined polyester fiber
- D. maglia polipropilene 70g / 70g polypropylene mesh

h 9

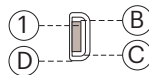

h 20

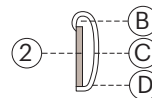

h 29

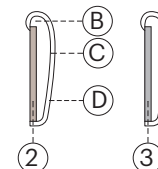

giroletti / bedframes

- 1. MDF 40mm / 40mm MDF
- B. espanso ignifugo D 35 kg/mc / fire resistant foam D 35 kg/mc
- C. resinato poliestere ignifugo 100g / 100g fire resistant resined polyester fiber
- D. maglia polipropilene 70g / 70g polypropylene mesh
- 2. listellare abete 22mm 3 strati / 22mm 3-layer fir blockboard
- 3. estruso in alluminio 22mm / 22 mm extruded aluminum

predisposto per materassi / for mattresses:

160 x 200	63" x 78 ⁶ / ₈ "
170 x 200	66 ⁷ / ₈ " x 78 ⁶ / ₈ "
180 x 200	70 ⁷ / ₈ " x 78 ⁶ / ₈ "

153 x 203	60" x 80"	Queen size
193 x 203	76" x 80"	King size

Karol / Firwood structure

Standard feet Vasetto - completely removable cover in fabric/eco-leather and non removable headboard cover in leather

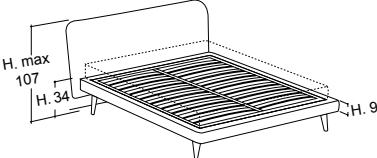
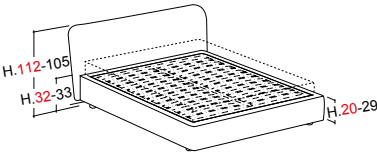
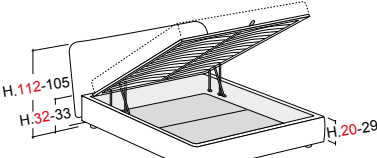
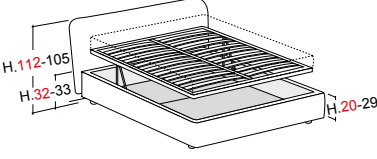
	Mattress	Ext. dimension	Code	D	C	A	Plus	Luxury fabric	Luxury leather	Nuvola fabric	Nuvola leather	TCL	Cover		
													ml	mc	kg
thin base h.9 orthopaedic slatted base included carrying slat															
	150x200	186x228	KRL9										7.6	0.62	78
	153x203 QUEEN 60X80"	186x228	KRQ9										7.6	0.62	78
	160x200	196x228	KRM9										8	0.64	80
	170x200	206x228	KRF9										8.5	0.67	84
	180x200	216x228	KRG9										9	0.7	88
	190x200	226x228	KRP9										10	0.75	94
	193x203 KING 76X80"	229x228	KRK9										10	0.75	94
	Loose cover		RKRM											0.02	8
rounded base h.20 - rounded base h.29 without slatted base (to choose a slatted base see flap on the right)															
	150x200	186x229	KRL29										9.3	0.64	66
	153x203 QUEEN 60X80"	189x232	KRQ29										9.3	0.64	66
	160x200	196x229	KRM29										9.5	0.65	68
	170x200	206x229	KRF29										10	0.67	72
	180x200	216x229	KRG29										10.5	0.7	75
	190x200	226x229	KRP29										11.5	0.74	80
	193x203 KING 76X80"	229x232	KRK29										11.5	0.74	80
Loose cover		RKRM											0.02	8	
rounded base h.20 - rounded base h.29 w/BOX orthopaedic slatted base included suggested weights for mattresses (see flap on the right)															
	150x200	186x229	KRL29B										9.3	0.88	126
	153x203 QUEEN 60X80"	189x232	KRQ29B										9.3	0.88	126
	160x200	196x229	KRM29B										9.5	0.9	128
	170x200	206x229	KRF29B										10	0.94	136
	180x200	216x229	KRG29B										10.5	0.98	142
	190x200	226x229	KRP29B										11.5	1.04	150
	193x203 KING 76X80"	229x232	KRK29B										11.5	1.04	150
available inside height in Box 12-18cm		RKRM											0.02	8	
rounded base h.20 - rounded base h.29 w/easy-up BOX orthopaedic slatted base included suggested weights for mattresses (see flap on the right)															
	150x200	186x229	KRL29BE										9.5	0.92	136
	153x203 QUEEN 60X80"	189x232	KRQ29BE										9.5	0.92	136
	160x200	196x229	KRM29BE										9.5	0.94	138
	170x200	206x229	KRF29BE										10	0.98	146
	180x200	216x229	KRG29BE										10.5	1.02	152
	190x200	226x229	KRP29BE										11.5	1.08	160
	193x203 KING 76X80"	229x232	KRK29BE										11.5	1.08	160
available inside height in Box 12-18cm		RKRM											0.02	8	

Karol / Aluminum structure

Standard feet Vasetto - completely removable cover in fabric/eco-leather and non removable headboard cover in leather

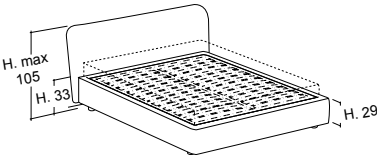
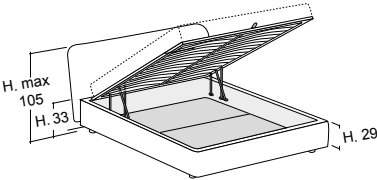
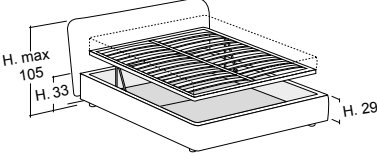
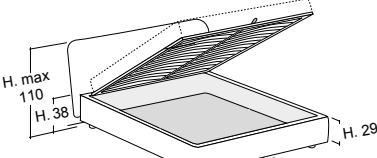
	Mattress	Ext. dimension	Code	D	C	A	Plus	Luxury fabric	Luxury leather	Nuvola fabric	Nuvola leather	TCL	Cover			
													ml	mc	kg	
rounded base h.29																
without slatted base (to choose a slatted base see flap on the right)																
	150x200	186x229	KRL29A										9.3	0.64	59	
	153x203 QUEEN 60x80"	189x232	KRQ29A										9.3	0.64	59	
	160x200	196x229	KRM29A										9.5	0.65	61	
	170x200	206x229	KRF29A										10	0.67	65	
	180x200	216x229	KRG29A										10.5	0.7	69	
	190x200	226x229	KRP29A										11.5	0.74	75	
	193x203 KING 76x80"	229x232	KRK29A										11.5	0.74	75	
	Loose cover		RKRMA											0.02		8
rounded base h.29 w/BOX																
orthopaedic slatted base included suggested weights for mattresses (see flap on the right)																
	150x200	186x229	KRL29BA										9.3	0.88	129	
	153x203 QUEEN 60x80"	189x232	KRQ29BA										9.3	0.88	129	
	160x200	196x229	KRM29BA										9.5	0.9	131	
	170x200	206x229	KRF29BA										10	0.94	139	
	180x200	216x229	KRG29BA										10.5	0.98	146	
	190x200	226x229	KRP29BA										11.5	1.04	155	
	193x203 KING 76x80"	229x232	KRK29BA										11.5	1.04	155	
	Loose cover		RKRMA											0.02		8
rounded base h.29 w/easy-up BOX																
orthopaedic slatted base included suggested weights for mattresses (see flap on the right)																
	150x200	186x229	KRL29BEA										9.5	0.92	139	
	153x203 QUEEN 60x80"	189x232	KRQ29BEA										9.5	0.92	139	
	160x200	196x229	KRM29BEA										9.5	0.94	141	
	170x200	206x229	KRF29BEA										10	0.98	149	
	180x200	216x229	KRG29BEA										10.5	1.02	156	
	190x200	226x229	KRP29BEA										11.5	1.08	165	
	193x203 KING 76x80"	229x232	KRK29BEA										11.5	1.08	165	
	Loose cover		RKRMA											0.02		8
rounded base h.29 w/HANDS FREE BOX																
orthopaedic slatted base included Specify mattress weight (see flap on the right)																
	150x200	186x232	KRL29BHF										9.3	0.92	135	
	153x203 QUEEN 60x80"	189x235	KRQ29BHF										9.3	0.92	135	
	160x200	196x232	KRM29BHF										9.5	0.94	137	
	170x200	206x232	KRF29BHF										10	0.98	145	
	180x200	216x232	KRG29BHF										10.5	1.02	153	
	190x200	226x232	KRP29BHF										11.5	1.08	163	
	193x203 KING 76x80"	229x235	KRK29BHF										11.5	1.08	163	
	Loose cover		RKRMHF											0.02		8

GIROLETTI E PIEDINI / BEDFRAMES AND FEET

pieдини in legno / wooden feet:

pieдини realizzati in legno di frassino con possibilità di essere tinti, verniciati ral o foderati in tessuto a scelta.

ash wood legs with the possibility of being dyed, RAL varnished or lined with fabric (of your choice)

pieдини in metallo / metal feet:

pieдини realizzati in metallo con possibilità di essere verniciati effetto ottone o colori ral.

metal legs with the possibility of being painted in brass effect or RAL varnished.

bedframe h.9 cm



cilindro
H 26 cm 10²/₈"



vasetto
H 26 cm 10²/₈"



vasetto inclinato
H 26 cm 10²/₈"

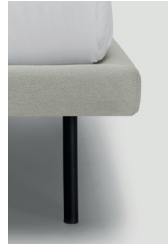

tubino
H 26 cm 10²/₈"



lamina
H 26 cm 10²/₈"



arco
H 26 cm 10²/₈"

bedframe h.20 cm



cilindro
H 12,5 cm 4⁷/₈"



vasetto
H 12,5 cm 4⁷/₈"



tubino
H 12,5 cm 4⁷/₈"



lamina
H 15 cm 5⁷/₈"

bedframe h.29 cm



vasetto h. 4cm
H 4 cm 1⁵/₈"



vasetto h. 9-12,5 cm
H 9 cm 3⁴/₈"
H 12,5 cm 4⁷/₈"



cipolla
H 8 cm 3¹/₈"

finiture legno tinto / lacquered wood finishes:



noce / walnut



ciliegio / cherry



rovere / oak



wengè

finiture metallo / metal finishes:



ottone satinato /
brushed brass

finiture laccati ral / ral lacquered finishes:



bianco / white
RAL 9010



nero / black
RAL 9011



grigio / grey
RAL 7044



marrone / brown
RAL 8019



rosso / red
RAL 3005



verde / green
RAL 6020



blu / blue
RAL 5008

h. 20-29 SISTEMA CONTENITORE / BOX SYSTEM



box

BOX

apertura basic del box grazie ad un semplice sistema a leva / basic opening of storage box thanks to a simple lever system

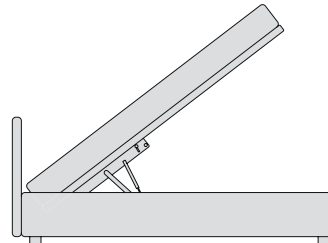

interno in legno



interno in alluminio
only for h29cm

HANDS-FREE solo per h.29 cm / only for h.29cm

apertura del box senza l'uso delle mani e grazie al box completamente in alluminio è privo di pistoncini a vista / The mechanism allows to open the storage box without hands, and thanks to its aluminum structure, the storage box has inner pistons, thus maintaining a top-notch design

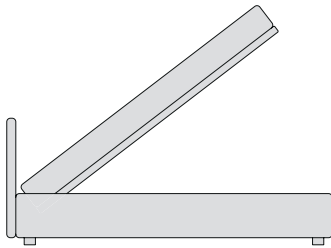

interno in alluminio
only for h29cm

EASY UP

grazie al movimento che mantiene la rete all'interno dello spazio occupato dal letto, ottimizza lo spazio all'interno della stanza / mechanism optimizes the space inside the room thanks to its movement that keeps the slatted base within the space occupied by the bed

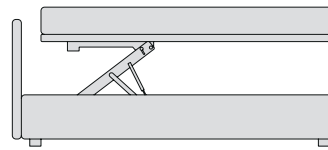

interno in legno



interno in alluminio
only for h29cm

h. 20-29 INCASSO MATERASSO / MATTRESS RECESS

La struttura dei letti Bolzan permette di soddisfare le diverse esigenze di progettazione: l'incasso del materasso nella struttura del letto è personalizzabile in 7 altezze diverse. Non disponibile per le basi con box.

Bolzan beds' structure allows you to meet different design needs: the mattress recess in the bed's structure is customizable in 7 different heights. It is not available for bases with box.

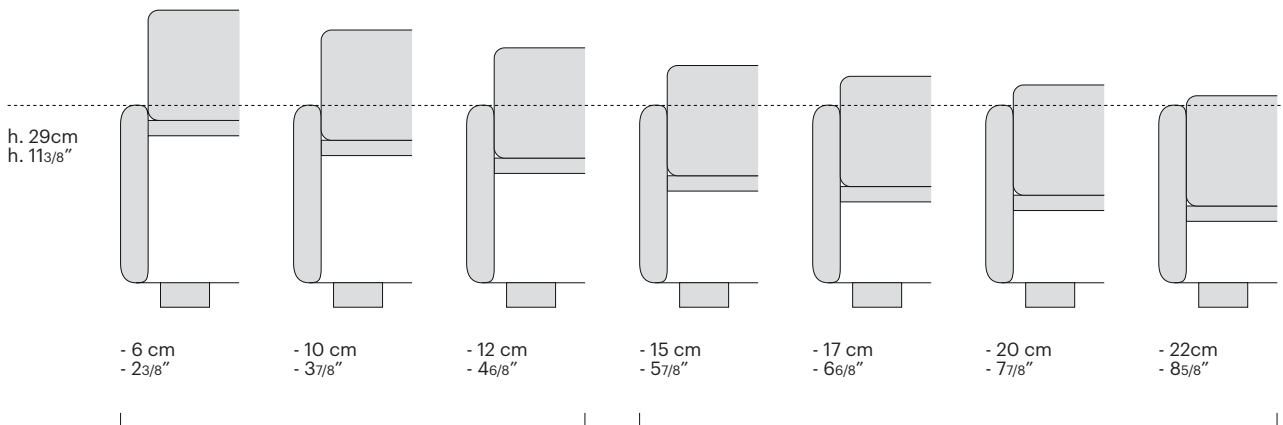

ribassamento disponibile per giroletto h. 20 e h. 29 cm /
mattress recess available for h. 20 and h. 29 cm bedframes

ribassamento disponibile solo per giroletto h. 29 cm /
mattress recess available for h. 29 cm bedframe