

freedom

design bolzan LAB



Un classico reinventato nel segno della sapienza stilistica e della cura sartoriale nei dettagli. Freedom veste l'essenzialità contemporanea delle sue linee, con il prestigio e il comfort della testiera capitonné. Le cuciture a vista del rivestimento, esprimono un valore artigianale e contribuiscono a creare un'estetica affascinante.

A re-invented classic in the sign of stylistic wisdom and tailoring care for details. Freedom symbolizes the contemporary simplicity of its lines, with the prestige and the comfort of its capitonné headboard. The seams at sight of its cover express a handicraft value and contribute creating a captivating appearance.

informazioni tecniche / technical info:

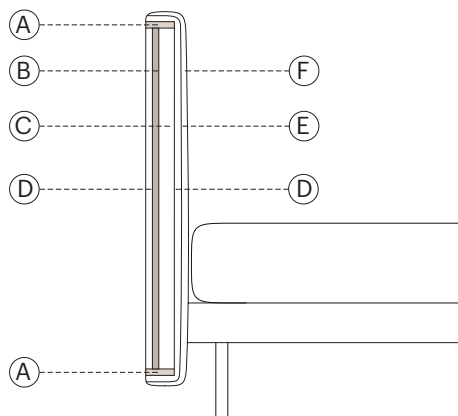

h 9

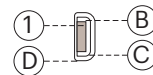

h 29

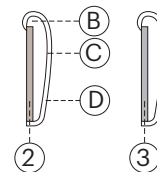

testata / headboard

- A. listellare abete 22mm 3 strati / 22mm 3-layer fir blockboard
- B. multistrato pioppo 18mm / 18mm poplar multilayer
- C. espanso ignifugo D 20 kg/mc / fire retardant foam D 20 kg/mc
- D. espanso ignifugo D 25 kg/mc / fire retardant foam D 25 kg/mc
- E. ovatta poliestere ignifuga 300g / 300g fire resistant resin polyester fibre
- F. maglina polipropilene 70g / 70g polypropylene mesh

giroletti / bedframes

- 1. MDF 40mm / 40mm MDF
- B. espanso ignifugo D 35 kg/mc / fire resistant foam D 35 kg/mc
- C. resinato poliestere ignifugo 100g / 100g fire resistant resined polyester fiber
- D. maglia polipropilene 70g / 70g polypropylene mesh
- 2. listellare abete 22mm 3 strati / 22mm 3-layer fir blockboard
- 3. estruso in alluminio 22mm / 22 mm extruded aluminum

predisposto per materassi / for mattresses:

| | |
|-----------|---|
| 90 x 200 | 35 ³ / ₈ " x 78 ⁶ / ₈ " |
| 120 x 200 | 47 ² / ₈ " x 78 ⁶ / ₈ " |
| 140 x 200 | 55 ¹ / ₈ " x 78 ⁶ / ₈ " |
| 160 x 200 | 63" x 78 ⁶ / ₈ " |
| 170 x 200 | 66 ⁷ / ₈ " x 78 ⁶ / ₈ " |
| 180 x 200 | 70 ⁷ / ₈ " x 78 ⁶ / ₈ " |

| | | |
|-----------|-----------|--------------------------|
| 137 x 190 | 54" x 75" | F ull double size |
| 153 x 203 | 60" x 80" | Q ueen size |
| 193 x 203 | 76" x 80" | K ing size |

Freedom / Firwood structure

Standard feet Vasetto - non removable headboard cover - available with or without buttons

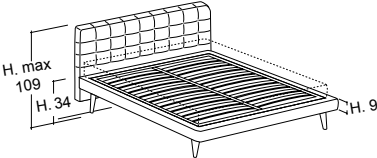
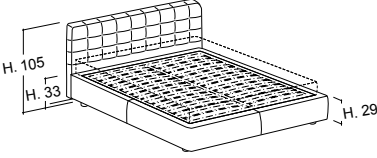
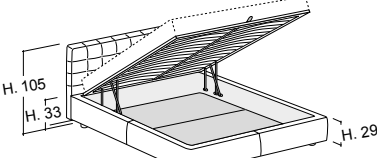
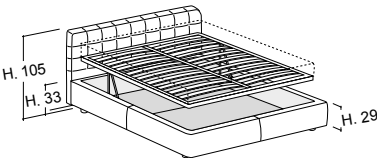
| | Mattress | Ext. dimension | Code | D | C | A | Plus | Luxury fabric | Luxury leather | Nuvola fabric | Nuvola leather | TCL | Cover | | |
|---|--------------------------------|----------------|----------------|---|---|---|------|---------------|----------------|---------------|----------------|-----|-------|------|-----|
| | | | | | | | | | | | | | ml | mc | kg |
| thin base h.9 orthopaedic slatted base included carrying slat  | 120x200 | 141x218 | FRD9 | | | | | | | | | | 7 | 0.36 | 61 |
| | 135x190 | 161x208 | FRI9 | | | | | | | | | | 7.4 | 0.38 | 67 |
| | 137x190 DOUBLE 54X75 | 161x208 | FRE9 | | | | | | | | | | 7.4 | 0.38 | 67 |
| | 140x200 | 161x218 | FRU9 | | | | | | | | | | 7.5 | 0.38 | 67 |
| | 150x200 | 181x218 | FRL9 | | | | | | | | | | 7.8 | 0.41 | 74 |
| | 153x203 QUEEN 60X80 | 181x218 | FRQ9 | | | | | | | | | | 7.8 | 0.41 | 74 |
| | 160x200 | 181x218 | FRM9 | | | | | | | | | | 8 | 0.41 | 74 |
| | 180x200 | 201x218 | FRG9 | | | | | | | | | | 8.5 | 0.43 | 80 |
| | 190x200 | 221x218 | FRP9 | | | | | | | | | | 9 | 0.45 | 86 |
| | 193x203 KING 76X80 | 221x218 | FRK9 | | | | | | | | | | 9 | 0.45 | 86 |
| | Loose cover | | R9 | | | | | | | | | | | 0.02 | 5 |
| rounded base h.29 without slatted base (to choose a slatted base see flap on the right)  | 120x200 | 141x221 | FRD29 | | | | | | | | | | 7 | 0.45 | 63 |
| | 135x190 | 161x211 | FRI29 | | | | | | | | | | 7.4 | 0.47 | 68 |
| | 137x190 DOUBLE 54X75 | 161x211 | FRE29 | | | | | | | | | | 7.4 | 0.47 | 68 |
| | 140x200 | 161x221 | FRU29 | | | | | | | | | | 7.5 | 0.47 | 68 |
| | 150x200 | 181x221 | FRL29 | | | | | | | | | | 7.8 | 0.5 | 74 |
| | 153x203 QUEEN 60X80 | 181x224 | FRQ29 | | | | | | | | | | 7.8 | 0.5 | 74 |
| | 160x200 | 181x221 | FRM29 | | | | | | | | | | 8 | 0.5 | 74 |
| | 180x200 | 201x221 | FRG29 | | | | | | | | | | 8.5 | 0.52 | 80 |
| | 190x200 | 221x221 | FRP29 | | | | | | | | | | 9 | 0.54 | 86 |
| | 193x203 KING 76X80 | 221x224 | FRK29 | | | | | | | | | | 9 | 0.54 | 86 |
| | Loose cover | | R29 | | | | | | | | | | | 0.02 | 5 |
| rounded base h.29 w/BOX orthopaedic slatted base included suggested weights for mattresses (see flap on the right)  | 120x200 | 141x221 | FRD29B | | | | | | | | | | 7 | 0.63 | 121 |
| | 135x190 | 161x211 | FRI29B | | | | | | | | | | 7.4 | 0.69 | 129 |
| | 137x190 DOUBLE 54X75 | 161x211 | FRE29B | | | | | | | | | | 7.4 | 0.69 | 129 |
| | 140x200 | 161x221 | FRU29B | | | | | | | | | | 7.5 | 0.69 | 129 |
| | 150x200 | 181x221 | FRL29B | | | | | | | | | | 7.8 | 0.75 | 139 |
| | 153x203 QUEEN 60X80 | 181x224 | FRQ29B | | | | | | | | | | 7.8 | 0.75 | 139 |
| | 160x200 | 181x221 | FRM29B | | | | | | | | | | 8 | 0.75 | 139 |
| | 180x200 | 201x221 | FRG29B | | | | | | | | | | 8.5 | 0.79 | 150 |
| | 190x200 | 221x221 | FRP29B | | | | | | | | | | 9 | 0.83 | 161 |
| | 193x203 KING 76X80 | 221x224 | FRK29B | | | | | | | | | | 9 | 0.83 | 161 |
| available inside height in Box 18cm | Loose cover | | R29B | | | | | | | | | | | 0.02 | 5 |
| rounded base h.29 w/easy-up BOX orthopaedic slatted base included suggested weights for mattresses (see flap on the right)  | 120x200 | 141x221 | FRD29BE | | | | | | | | | | 7 | 0.67 | 131 |
| | 135x190 | 161x211 | FRI29BE | | | | | | | | | | 7.4 | 0.73 | 139 |
| | 137x190 DOUBLE 54X75 | 161x211 | FRE29BE | | | | | | | | | | 7.4 | 0.73 | 139 |
| | 140x200 | 161x221 | FRU29BE | | | | | | | | | | 7.5 | 0.73 | 139 |
| | 150x200 | 181x221 | FRL29BE | | | | | | | | | | 7.8 | 0.79 | 149 |
| | 153x203 QUEEN 60X80 | 181x224 | FRQ29BE | | | | | | | | | | 7.8 | 0.79 | 149 |
| | 160x200 | 181x221 | FRM29BE | | | | | | | | | | 8 | 0.79 | 149 |
| | 180x200 | 201x221 | FRG29BE | | | | | | | | | | 8.5 | 0.83 | 160 |
| | 190x200 | 221x221 | FRP29BE | | | | | | | | | | 9 | 0.87 | 171 |
| | 193x203 KING 76X80 | 221x224 | FRK29BE | | | | | | | | | | 9 | 0.87 | 171 |
| available inside height in Box 18cm | Loose cover | | R29BE | | | | | | | | | | | 0.02 | 5 |

Freedom / Aluminum structure

Standard feet Vasetto - non removable headboard cover - available with or without buttons

| | Mattress | Ext. dimension | Code | D | C | A | Plus | Luxury fabric | Luxury leather | Nuvola fabric | Nuvola leather | TCL | Cover | | |
|---|--------------------------|--------------------|-----------------|---------------|---|---|------|---------------|----------------|---------------|----------------|-----|-------|------|------|
| | | | | | | | | | | | | | ml | mc | kg |
| rounded base h.29 without slatted base (to choose a slatted base see flap on the right) | 120x200 | 141x221 | FRD29A | | | | | | | | | | 7 | 0.45 | 64 |
| | 135x190 | 161x211 | FRI29A | | | | | | | | | | 7.4 | 0.47 | 70 |
| | 137x190 DOUBLE 54X75" | 161x211 | FRE29A | | | | | | | | | | 7.4 | 0.47 | 70 |
| | 140x200 | 161x221 | FRU29A | | | | | | | | | | 7.5 | 0.47 | 70 |
| | 150x200 | 181x221 | FRL29A | | | | | | | | | | 7.8 | 0.5 | 77 |
| | 153x203 QUEEN 60X80" | 181x224 | FRQ29A | | | | | | | | | | 7.8 | 0.5 | 77 |
| | 160x200 | 181x221 | FRM29A | | | | | | | | | | 8 | 0.5 | 77 |
| | 180x200 | 201x221 | FRG29A | | | | | | | | | | 8.5 | 0.52 | 84 |
| | 190x200 | 221x221 | FRP29A | | | | | | | | | | 9 | 0.54 | 91 |
| | 193x203 KING 76X80" | 221x224 | FRK29A | | | | | | | | | | 9 | 0.54 | 91 |
| | | Loose cover | | R29A | | | | | | | | | | | 0.02 |
| rounded base h.29 w/BOX orthopaedic slatted base included suggested weights for mattresses (see flap on the right) | 120x200 | 141x221 | FRD29BA | | | | | | | | | | 7 | 0.63 | 122 |
| | 135x190 | 161x211 | FRI29BA | | | | | | | | | | 7.4 | 0.69 | 131 |
| | 137x190 DOUBLE 54X75" | 161x211 | FRE29BA | | | | | | | | | | 7.4 | 0.69 | 131 |
| | 140x200 | 161x221 | FRU29BA | | | | | | | | | | 7.5 | 0.69 | 131 |
| | 150x200 | 181x221 | FRL29BA | | | | | | | | | | 7.8 | 0.75 | 142 |
| | 153x203 QUEEN 60X80" | 181x224 | FRQ29BA | | | | | | | | | | 7.8 | 0.75 | 142 |
| | 160x200 | 181x221 | FRM29BA | | | | | | | | | | 8 | 0.75 | 142 |
| | 180x200 | 201x221 | FRG29BA | | | | | | | | | | 8.5 | 0.79 | 154 |
| | 190x200 | 221x221 | FRP29BA | | | | | | | | | | 9 | 0.83 | 166 |
| | 193x203 KING 76X80" | 221x224 | FRK29BA | | | | | | | | | | 9 | 0.83 | 166 |
| | | Loose cover | | R29BA | | | | | | | | | | | 0.02 |
| rounded base h.29 w/easy-up BOX orthopaedic slatted base included suggested weights for mattresses (see flap on the right) | 120x200 | 141x221 | FRD29BEA | | | | | | | | | | 7 | 0.67 | 132 |
| | 135x190 | 161x211 | FRI29BEA | | | | | | | | | | 7.4 | 0.73 | 141 |
| | 137x190 DOUBLE 54X75" | 161x211 | FRE29BEA | | | | | | | | | | 7.4 | 0.73 | 141 |
| | 140x200 | 161x221 | FRU29BEA | | | | | | | | | | 7.5 | 0.73 | 141 |
| | 150x200 | 181x221 | FRL29BEA | | | | | | | | | | 7.8 | 0.79 | 152 |
| | 153x203 QUEEN 60X80" | 181x224 | FRQ29BEA | | | | | | | | | | 7.8 | 0.79 | 152 |
| | 160x200 | 181x221 | FRM29BEA | | | | | | | | | | 8 | 0.79 | 152 |
| | 180x200 | 201x221 | FRG29BEA | | | | | | | | | | 8.5 | 0.83 | 164 |
| | 190x200 | 221x221 | FRP29BEA | | | | | | | | | | 9 | 0.87 | 176 |
| | 193x203 KING 76X80" | 221x224 | FRK29BEA | | | | | | | | | | 9 | 0.87 | 176 |
| | | Loose cover | | R29BEA | | | | | | | | | | | 0.02 |
| rounded base h.29 w/HANDS FREE BOX orthopaedic slatted base included Specify mattress weight (see flap on the right) | 150x200 | 181x224 | FRL29BHF | | | | | | | | | | 7.8 | 0.79 | 148 |
| | 160x200 | 181x224 | FRM29BHF | | | | | | | | | | 8 | 0.79 | 148 |
| | 180x200 | 201x224 | FRG29BHF | | | | | | | | | | 8.5 | 0.83 | 161 |
| | 190x200 | 221x224 | FRP29BHF | | | | | | | | | | 9 | 0.87 | 174 |
| | 193x203 KING 76X80" | 221x227 | FRK29BHF | | | | | | | | | | 9 | 0.87 | 174 |
| | | Loose cover | | R29BHF | | | | | | | | | | | 0.02 |

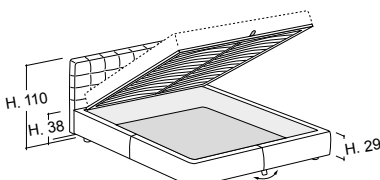
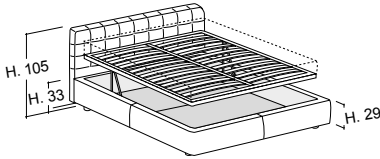
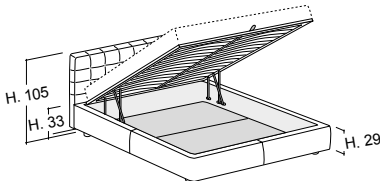
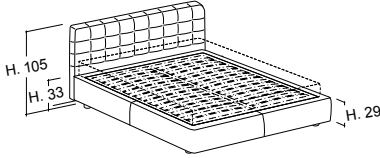

Freedom Medium / Firwood structure

Standard feet Vasetto - non removable headboard cover - available with or without buttons

| | Mattress | Ext. dimension | Code | D | C | A | Plus | Luxury fabric | Luxury leather | Nuvola fabric | Nuvola leather | TCL | Cover | | | |
|---|--------------------------|----------------|-----------------|---|---|---|------|---------------|----------------|---------------|----------------|-----|-------|------|-----|--|
| | | | | | | | | | | | | | ml | mc | kg | |
| rounded base h.29 | | | | | | | | | | | | | | | | |
| without slatted base (to choose a slatted base see flap on the right) | | | | | | | | | | | | | | | | |
| | 120x200 | 141x221 | FRMD29 | | | | | | | | | | 7.5 | 0.49 | 66 | |
| | 135x190 | 161x211 | FRMI29 | | | | | | | | | | 7.9 | 0.52 | 72 | |
| | 137x190 DOUBLE 54X75" | 161x211 | FRME29 | | | | | | | | | | 7.9 | 0.52 | 72 | |
| | 140x200 | 161x221 | FRMU29 | | | | | | | | | | 8 | 0.52 | 72 | |
| | 150x200 | 181x221 | FRML29 | | | | | | | | | | 8.3 | 0.55 | 78 | |
| | 153x203 QUEEN 60X80" | 181x224 | FRMQ29 | | | | | | | | | | 8.3 | 0.55 | 78 | |
| | 160x200 | 181x221 | FRMM29 | | | | | | | | | | 8.5 | 0.55 | 78 | |
| | 180x200 | 201x221 | FRMG29 | | | | | | | | | | 9 | 0.58 | 85 | |
| | 190x200 | 221x221 | FRMP29 | | | | | | | | | | 9.5 | 0.61 | 92 | |
| | 193x203 KING 76X80" | 221x224 | FRMK29 | | | | | | | | | | 9.5 | 0.61 | 92 | |
| | Loose cover | | R29 | | | | | | | | | | | 0.02 | 5 | |
| rounded base h.29 w/BOX | | | | | | | | | | | | | | | | |
| orthopaedic slatted base included suggested weights for mattresses (see flap on the right) | | | | | | | | | | | | | | | | |
| | 120x200 | 141x221 | FRMD29B | | | | | | | | | | 7.5 | 0.67 | 124 | |
| | 135x190 | 161x211 | FRMI29B | | | | | | | | | | 7.9 | 0.74 | 133 | |
| | 137x190 DOUBLE 54X75" | 161x211 | FRME29B | | | | | | | | | | 7.9 | 0.74 | 133 | |
| | 140x200 | 161x221 | FRMU29B | | | | | | | | | | 8 | 0.74 | 133 | |
| | 150x200 | 181x221 | FRML29B | | | | | | | | | | 8.3 | 0.8 | 143 | |
| | 153x203 QUEEN 60X80" | 181x224 | FRMQ29B | | | | | | | | | | 8.3 | 0.8 | 143 | |
| | 160x200 | 181x221 | FRMM29B | | | | | | | | | | 8.5 | 0.8 | 143 | |
| | 180x200 | 201x221 | FRMG29B | | | | | | | | | | 9 | 0.85 | 155 | |
| | 190x200 | 221x221 | FRMP29B | | | | | | | | | | 9.5 | 0.9 | 167 | |
| | 193x203 KING 76X80" | 221x224 | FRMK29B | | | | | | | | | | 9.5 | 0.9 | 167 | |
| | Loose cover | | R29B | | | | | | | | | | | 0.02 | 5 | |
| rounded base h.29 w/easy-up BOX | | | | | | | | | | | | | | | | |
| orthopaedic slatted base included suggested weights for mattresses (see flap on the right) | | | | | | | | | | | | | | | | |
| | 120x200 | 141x221 | FRMD29BE | | | | | | | | | | 7.5 | 0.71 | 134 | |
| | 135x190 | 161x211 | FRMI29BE | | | | | | | | | | 7.9 | 0.78 | 143 | |
| | 137x190 DOUBLE 54X75" | 161x211 | FRME29BE | | | | | | | | | | 7.9 | 0.78 | 143 | |
| | 140x200 | 161x221 | FRMU29BE | | | | | | | | | | 8 | 0.78 | 143 | |
| | 150x200 | 181x221 | FRML29BE | | | | | | | | | | 8.3 | 0.84 | 153 | |
| | 153x203 QUEEN 60X80" | 181x224 | FRMQ29BE | | | | | | | | | | 8.3 | 0.84 | 153 | |
| | 160x200 | 181x221 | FRMM29BE | | | | | | | | | | 8.5 | 0.84 | 153 | |
| | 180x200 | 201x221 | FRMG29BE | | | | | | | | | | 9 | 0.89 | 165 | |
| | 190x200 | 221x221 | FRMP29BE | | | | | | | | | | 9.5 | 0.94 | 177 | |
| | 193x203 KING 76X80" | 221x224 | FRMK29BE | | | | | | | | | | 9.5 | 0.94 | 177 | |
| | Loose cover | | R29BE | | | | | | | | | | | 0.02 | 5 | |

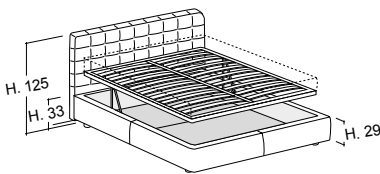
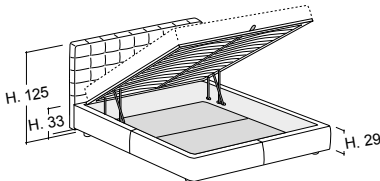
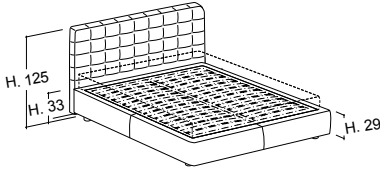

available inside height in Box 18cm

Freedom Medium / Aluminum structure

Standard feet Vasetto - non removable headboard cover - available with or without buttons

| | Mattress | Ext. dimension | Code | D | C | A | Plus | Luxury fabric | Luxury leather | Nuvola fabric | Nuvola leather | TCL | Cover | | |
|---|-------------------------|----------------|-----------|--------|---|---|------|---------------|----------------|---------------|----------------|-----|-------|------|------|
| | | | | | | | | | | | | | ml | mc | kg |
| rounded base h.29 without slatted base (to choose a slatted base see flap on the right) | 120x200 | 141x221 | FRMD29A | | | | | | | | | | 7.5 | 0.49 | 67 |
| | 135x190 | 161x211 | FRMI29A | | | | | | | | | | 7.9 | 0.52 | 74 |
| | 137x190 DOUBLE 54X75 | 161x211 | FRME29A | | | | | | | | | | 7.9 | 0.52 | 74 |
| | 140x200 | 161x221 | FRMU29A | | | | | | | | | | 8 | 0.52 | 74 |
| | 150x200 | 181x221 | FRML29A | | | | | | | | | | 8.3 | 0.55 | 81 |
| | 153x203 QUEEN 60X80 | 181x224 | FRMQ29A | | | | | | | | | | 8.3 | 0.55 | 81 |
| | 160x200 | 181x221 | FRMM29A | | | | | | | | | | 8.5 | 0.55 | 81 |
| | 180x200 | 201x221 | FRMG29A | | | | | | | | | | 9 | 0.58 | 89 |
| | 190x200 | 221x221 | FRMP29A | | | | | | | | | | 9.5 | 0.61 | 97 |
| | 193x203 KING 76X80 | 221x224 | FRMK29A | | | | | | | | | | 9.5 | 0.61 | 97 |
| | Loose cover | | R29A | | | | | | | | | | | 0.02 | 5 |
| rounded base h.29 w/BOX orthopaedic slatted base included suggested weights for mattresses (see flap on the right) | 120x200 | 141x221 | FRMD29BA | | | | | | | | | | 7.5 | 0.67 | 125 |
| | 135x190 | 161x211 | FRMI29BA | | | | | | | | | | 7.9 | 0.74 | 135 |
| | 137x190 DOUBLE 54X75 | 161x211 | FRME29BA | | | | | | | | | | 7.9 | 0.74 | 135 |
| | 140x200 | 161x221 | FRMU29BA | | | | | | | | | | 8 | 0.74 | 135 |
| | 150x200 | 181x221 | FRML29BA | | | | | | | | | | 8.3 | 0.8 | 146 |
| | 153x203 QUEEN 60X80 | 181x224 | FRMQ29BA | | | | | | | | | | 8.3 | 0.8 | 146 |
| | 160x200 | 181x221 | FRMM29BA | | | | | | | | | | 8.5 | 0.8 | 146 |
| | 180x200 | 201x221 | FRMG29BA | | | | | | | | | | 9 | 0.85 | 159 |
| | 190x200 | 221x221 | FRMP29BA | | | | | | | | | | 9.5 | 0.9 | 172 |
| | 193x203 KING 76X80 | 221x224 | FRMK29BA | | | | | | | | | | 9.5 | 0.9 | 172 |
| | Loose cover | | R29BA | | | | | | | | | | | 0.02 | 5 |
| rounded base h.29 w/easy-up BOX orthopaedic slatted base included suggested weights for mattresses (see flap on the right) | 120x200 | 141x221 | FRMD29BEA | | | | | | | | | | 7.5 | 0.71 | 135 |
| | 135x190 | 161x211 | FRMI29BEA | | | | | | | | | | 7.9 | 0.78 | 145 |
| | 137x190 DOUBLE 54X75 | 161x211 | FRME29BEA | | | | | | | | | | 7.9 | 0.78 | 145 |
| | 140x200 | 161x221 | FRMU29BEA | | | | | | | | | | 8 | 0.78 | 145 |
| | 150x200 | 181x221 | FRML29BEA | | | | | | | | | | 8.3 | 0.84 | 156 |
| | 153x203 QUEEN 60X80 | 181x224 | FRMQ29BEA | | | | | | | | | | 8.3 | 0.84 | 156 |
| | 160x200 | 181x221 | FRMM29BEA | | | | | | | | | | 8.5 | 0.84 | 156 |
| | 180x200 | 201x221 | FRMG29BEA | | | | | | | | | | 9 | 0.89 | 169 |
| | 190x200 | 221x221 | FRMP29BEA | | | | | | | | | | 9.5 | 0.94 | 182 |
| | 193x203 KING 76X80 | 221x224 | FRMK29BEA | | | | | | | | | | 9.5 | 0.94 | 182 |
| | Loose cover | | R29BEA | | | | | | | | | | | 0.02 | 5 |
| rounded base h.29 w/HANDS FREE BOX orthopaedic slatted base included Specify mattress weight (see flap on the right) | 150x200 | 181x224 | FRML29BHF | | | | | | | | | | 8.3 | 0.84 | 154 |
| | 153x203 QUEEN 60X80 | 181x227 | FRMQ29BHF | | | | | | | | | | 8.3 | 0.84 | 154 |
| | 160x200 | 181x224 | FRMM29BHF | | | | | | | | | | 8.5 | 0.84 | 154 |
| | 180x200 | 201x224 | FRMG29BHF | | | | | | | | | | 9 | 0.89 | 166 |
| | 190x200 | 221x224 | FRMP29BHF | | | | | | | | | | 9.5 | 0.94 | 180 |
| | 193x203 KING 76X80 | 221x227 | FRMK29BHF | | | | | | | | | | 9.5 | 0.94 | 180 |
| | | Loose cover | | R29BHF | | | | | | | | | | | 0.02 |

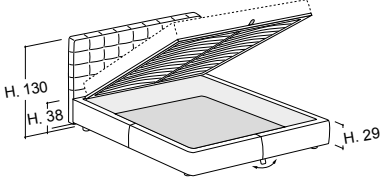
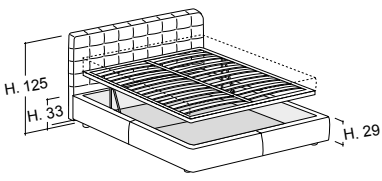
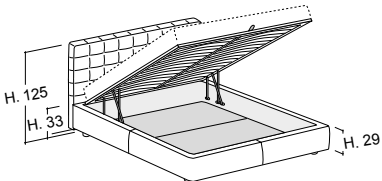
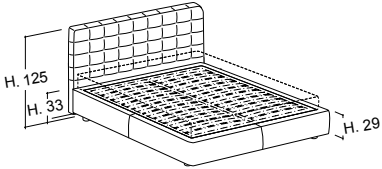

Freedom Big / Firwood structure

Standard feet Vasetto - non removable headboard cover - available with or without buttons

| | Mattress | Ext. dimension | Code | D | C | A | Plus | Luxury fabric | Luxury leather | Nuvola fabric | Nuvola leather | TCL | Cover | | |
|---|--------------------------|----------------|-----------------|---|---|---|------|---------------|----------------|---------------|----------------|-----|-------|------|-----|
| | | | | | | | | | | | | | ml | mc | kg |
| rounded base h.29 without slatted base (to choose a slatted base see flap on the right) | 120x200 | 141x221 | FRBD29 | | | | | | | | | | 8 | 0.52 | 71 |
| | 135x190 | 161x211 | FRBI29 | | | | | | | | | | 8.4 | 0.56 | 77 |
| | 137x190 DOUBLE 54X75" | 161x211 | FRBE29 | | | | | | | | | | 8.4 | 0.56 | 77 |
| | 140x200 | 161x221 | FRBU29 | | | | | | | | | | 8.5 | 0.56 | 77 |
| | 150x200 | 181x221 | FRBL29 | | | | | | | | | | 8.8 | 0.6 | 82 |
| | 153x203 QUEEN 60X80" | 181x224 | FRBQ29 | | | | | | | | | | 8.8 | 0.6 | 82 |
| | 160x200 | 181x221 | FRBM29 | | | | | | | | | | 9 | 0.6 | 82 |
| | 180x200 | 201x221 | FRBG29 | | | | | | | | | | 9.5 | 0.64 | 87 |
| | 190x200 | 221x221 | FRBP29 | | | | | | | | | | 10 | 0.68 | 92 |
| | 193x203 KING 76X80" | 221x224 | FRBK29 | | | | | | | | | | 10 | 0.68 | 92 |
| | Loose cover | | R29 | | | | | | | | | | | 0.02 | 5 |
| rounded base h.29 w/BOX orthopaedic slatted base included suggested weights for mattresses (see flap on the right) | 120x200 | 141x221 | FRBD29B | | | | | | | | | | 8 | 0.71 | 129 |
| | 135x190 | 161x211 | FRBI29B | | | | | | | | | | 8.4 | 0.78 | 138 |
| | 137x190 DOUBLE 54X75" | 161x211 | FRBE29B | | | | | | | | | | 8.4 | 0.78 | 138 |
| | 140x200 | 161x221 | FRBU29B | | | | | | | | | | 8.5 | 0.78 | 138 |
| | 150x200 | 181x221 | FRBL29B | | | | | | | | | | 8.8 | 0.85 | 147 |
| | 153x203 QUEEN 60X80" | 181x224 | FRBQ29B | | | | | | | | | | 8.8 | 0.85 | 147 |
| | 160x200 | 181x221 | FRBM29B | | | | | | | | | | 9 | 0.85 | 147 |
| | 180x200 | 201x221 | FRBG29B | | | | | | | | | | 9.5 | 0.9 | 159 |
| | 190x200 | 221x221 | FRBP29B | | | | | | | | | | 10 | 0.95 | 171 |
| | 193x203 KING 76X80" | 221x224 | FRBK29B | | | | | | | | | | 10 | 0.95 | 171 |
| available inside height in Box 18cm | Loose cover | | R29B | | | | | | | | | | | 0.02 | 5 |
| rounded base h.29 w/easy-up BOX orthopaedic slatted base included suggested weights for mattresses (see flap on the right) | 120x200 | 141x221 | FRBD29BE | | | | | | | | | | 8 | 0.75 | 139 |
| | 135x190 | 161x211 | FRBI29BE | | | | | | | | | | 8.4 | 0.82 | 148 |
| | 137x190 DOUBLE 54X75" | 161x213 | FRBE29BE | | | | | | | | | | 8.4 | 0.82 | 148 |
| | 140x200 | 161x221 | FRBU29BE | | | | | | | | | | 8.5 | 0.82 | 148 |
| | 150x200 | 181x221 | FRBL29BE | | | | | | | | | | 8.8 | 0.89 | 157 |
| | 153x203 QUEEN 60X80" | 181x226 | FRBQ29BE | | | | | | | | | | 8.8 | 0.89 | 157 |
| | 160x200 | 181x221 | FRBM29BE | | | | | | | | | | 9 | 0.89 | 157 |
| | 180x200 | 201x221 | FRBG29BE | | | | | | | | | | 9.5 | 0.94 | 169 |
| | 190x200 | 221x221 | FRBP29BE | | | | | | | | | | 10 | 0.99 | 181 |
| | 193x203 KING 76X80" | 221x226 | FRBK29BE | | | | | | | | | | 10 | 0.99 | 181 |
| available inside height in Box 18cm | Loose cover | | R29BE | | | | | | | | | | | 0.02 | 5 |

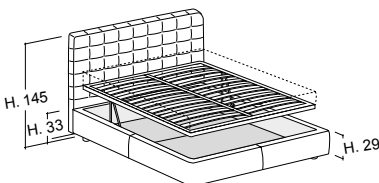
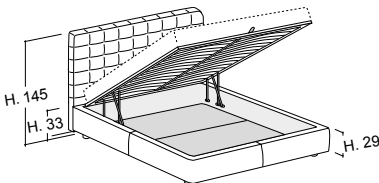
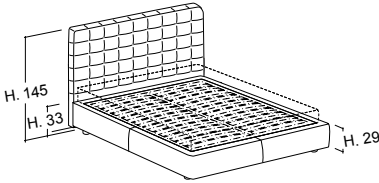

Freedom Big / Aluminum structure

Standard feet Vasetto - non removable headboard cover - available with or without buttons

| | Mattress | Ext. dimension | Code | D | C | A | Plus | Luxury fabric | Luxury leather | Nuvola fabric | Nuvola leather | TCL | Cover | | | |
|---|--------------------------|--------------------|-----------|---------------|---|---|------|---------------|----------------|---------------|----------------|-----|-------|------|------|---|
| | | | | | | | | | | | | | ml | mc | kg | |
| rounded base h.29 without slatted base (to choose a slatted base see flap on the right) | 120x200 | 141x221 | FRBD29A | | | | | | | | | | 8 | 0.52 | 72 | |
| | 135x190 | 161x211 | FRBI29A | | | | | | | | | | 8.4 | 0.56 | 79 | |
| | 137x190 DOUBLE 54X75" | 161x211 | FRBE29A | | | | | | | | | | 8.4 | 0.56 | 79 | |
| | 140x200 | 161x221 | FRBU29A | | | | | | | | | | 8.5 | 0.56 | 79 | |
| | 150x200 | 181x221 | FRBL29A | | | | | | | | | | 8.8 | 0.6 | 85 | |
| | 153x203 QUEEN 60X80" | 181x224 | FRBQ29A | | | | | | | | | | 8.8 | 0.6 | 85 | |
| | 160x200 | 181x221 | FRBM29A | | | | | | | | | | 9 | 0.6 | 85 | |
| | 180x200 | 201x221 | FRBG29A | | | | | | | | | | 9.5 | 0.64 | 91 | |
| | 190x200 | 221x221 | FRBP29A | | | | | | | | | | 10 | 0.68 | 97 | |
| | 193x203 KING 76X80" | 221x224 | FRBK29A | | | | | | | | | | 10 | 0.68 | 97 | |
| | | Loose cover | | R29A | | | | | | | | | | | 0.02 | 5 |
| rounded base h.29 w/BOX orthopaedic slatted base included suggested weights for mattresses (see flap on the right) | 120x200 | 141x221 | FRBD29BA | | | | | | | | | | 8 | 0.71 | 130 | |
| | 135x190 | 161x211 | FRBI29BA | | | | | | | | | | 8.4 | 0.78 | 140 | |
| | 137x190 DOUBLE 54X75" | 161x211 | FRBE29BA | | | | | | | | | | 8.4 | 0.78 | 140 | |
| | 140x200 | 161x221 | FRBU29BA | | | | | | | | | | 8.5 | 0.78 | 140 | |
| | 150x200 | 181x221 | FRBL29BA | | | | | | | | | | 8.8 | 0.85 | 150 | |
| | 153x203 QUEEN 60X80" | 181x224 | FRBQ29BA | | | | | | | | | | 8.8 | 0.85 | 150 | |
| | 160x200 | 181x221 | FRBM29BA | | | | | | | | | | 9 | 0.85 | 150 | |
| | 180x200 | 201x221 | FRBG29BA | | | | | | | | | | 9.5 | 0.9 | 163 | |
| | 190x200 | 221x221 | FRBP29BA | | | | | | | | | | 10 | 0.95 | 176 | |
| | 193x203 KING 76X80" | 221x224 | FRBK29BA | | | | | | | | | | 10 | 0.95 | 176 | |
| | | Loose cover | | R29BA | | | | | | | | | | | 0.02 | 5 |
| rounded base h.29 w/easy-up BOX orthopaedic slatted base included suggested weights for mattresses (see flap on the right) | 120x200 | 141x221 | FRBD29BEA | | | | | | | | | | 8 | 0.75 | 140 | |
| | 135x190 | 161x211 | FRBI29BEA | | | | | | | | | | 8.4 | 0.82 | 150 | |
| | 137x190 DOUBLE 54X75" | 161x211 | FRBE29BEA | | | | | | | | | | 8.4 | 0.82 | 150 | |
| | 140x200 | 161x221 | FRBU29BEA | | | | | | | | | | 8.5 | 0.82 | 150 | |
| | 150x200 | 181x221 | FRBL29BEA | | | | | | | | | | 8.8 | 0.89 | 160 | |
| | 153x203 QUEEN 60X80" | 181x224 | FRBQ29BEA | | | | | | | | | | 8.8 | 0.89 | 160 | |
| | 160x200 | 181x221 | FRBM29BEA | | | | | | | | | | 9 | 0.89 | 160 | |
| | 180x200 | 201x221 | FRBG29BEA | | | | | | | | | | 9.5 | 0.94 | 173 | |
| | 190x200 | 221x221 | FRBP29BEA | | | | | | | | | | 10 | 0.99 | 186 | |
| | 193x203 KING 76X80" | 221x224 | FRBK29BEA | | | | | | | | | | 10 | 0.99 | 186 | |
| | | Loose cover | | R29BEA | | | | | | | | | | | 0.02 | 5 |
| rounded base h.29 w/HANDS FREE BOX orthopaedic slatted base included Specify mattress weight (see flap on the right) | 150x200 | 181x224 | FRBL29BHF | | | | | | | | | | 8.8 | 0.89 | 156 | |
| | 153x203 QUEEN 60X80" | 181x227 | FRBQ29BHF | | | | | | | | | | 8.8 | 0.89 | 156 | |
| | 160x200 | 181x224 | FRBM29BHF | | | | | | | | | | 9 | 0.89 | 156 | |
| | 180x200 | 201x224 | FRBG29BHF | | | | | | | | | | 9.5 | 0.94 | 170 | |
| | 190x200 | 221x224 | FRBP29BHF | | | | | | | | | | 10 | 0.99 | 184 | |
| | 193x203 KING 76X80" | 221x227 | FRBK29BHF | | | | | | | | | | 10 | 0.99 | 184 | |
| | | Loose cover | | R29BHF | | | | | | | | | | | 0.02 | |

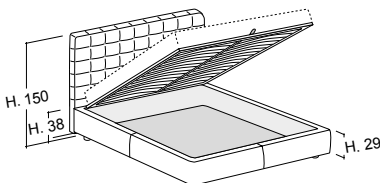
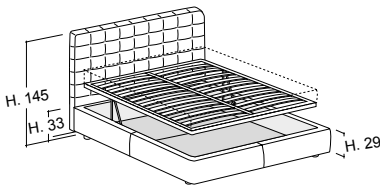
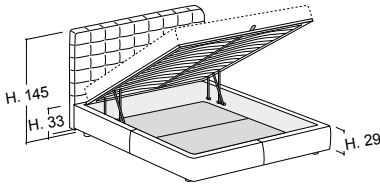
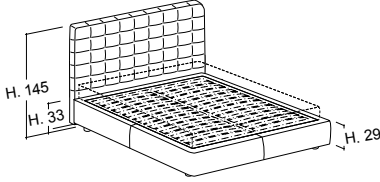

GIROLETTI E PIEDINI / BEDFRAMES AND FEET

pieдини in legno / wooden feet:

pieдини realizzati in legno di frassino con possibilità di essere tinti, verniciati ral o foderati in tessuto a scelta.

ash wood legs with the possibility of being dyed, RAL varnished or lined with fabric (of your choice)

pieдини in metallo / metal feet:

pieдини realizzati in metallo con possibilità di essere verniciati effetto ottone o colori ral.

metal legs with the possibility of being painted in brass effect or RAL varnished.

bedframe h.9 cm



cilindro
H 26 cm 10²/₈"



vasetto
H 26 cm 10²/₈"



vasetto inclinato
H 26 cm 10²/₈"

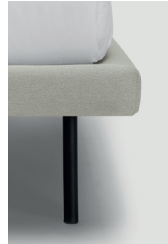

tubino
H 26 cm 10²/₈"



lamina
H 26 cm 10²/₈"



arco
H 26 cm 10²/₈"

bedframe h.20 cm



cilindro
H 12,5 cm 4⁷/₈"



vasetto
H 12,5 cm 4⁷/₈"



tubino
H 12,5 cm 4⁷/₈"



lamina
H 15 cm 5⁷/₈"

bedframe h.29 cm



vasetto h. 4cm
H 4 cm 1⁵/₈"



vasetto h. 9-12,5 cm
H 9 cm 3⁴/₈"
H 12,5 cm 4⁷/₈"



cipolla
H 8 cm 3¹/₈"

finiture legno tinto / lacquered wood finishes:



noce / walnut



ciliegio / cherry



rovere / oak



wengè

finiture metallo / metal finishes:



ottone satinato /
brushed brass

finiture laccati ral / ral lacquered finishes:



bianco / white
RAL 9010



nero / black
RAL 9011



grigio / grey
RAL 7044



marrone / brown
RAL 8019



rosso / red
RAL 3005



verde / green
RAL 6020



blu / blue
RAL 5008

h. 20-29 SISTEMA CONTENITORE / BOX SYSTEM



box

BOX

apertura basic del box grazie ad un semplice sistema a leva / basic opening of storage box thanks to a simple lever system

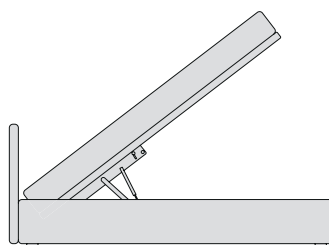

interno in legno



interno in alluminio
only for h29cm

HANDS-FREE solo per h.29 cm / only for h.29cm

apertura del box senza l'uso delle mani e grazie al box completamente in alluminio è privo di pistoncini a vista / The mechanism allows to open the storage box without hands, and thanks to its aluminum structure, the storage box has inner pistons, thus maintaining a top-notch design

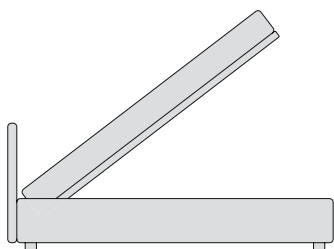

interno in alluminio
only for h29cm

EASY UP

grazie al movimento che mantiene la rete all'interno dello spazio occupato dal letto, ottimizza lo spazio all'interno della stanza / mechanism optimizes the space inside the room thanks to its movement that keeps the slatted base within the space occupied by the bed

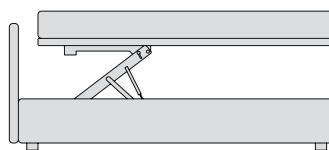

interno in legno



interno in alluminio
only for h29cm

h. 20-29 INCASSO MATERASSO / MATTRESS RECESS

La struttura dei letti Bolzan permette di soddisfare le diverse esigenze di progettazione: l'incasso del materasso nella struttura del letto è personalizzabile in 7 altezze diverse. Non disponibile per le basi con box.

Bolzan beds' structure allows you to meet different design needs: the mattress recess in the bed's structure is customizable in 7 different heights. It is not available for bases with box.

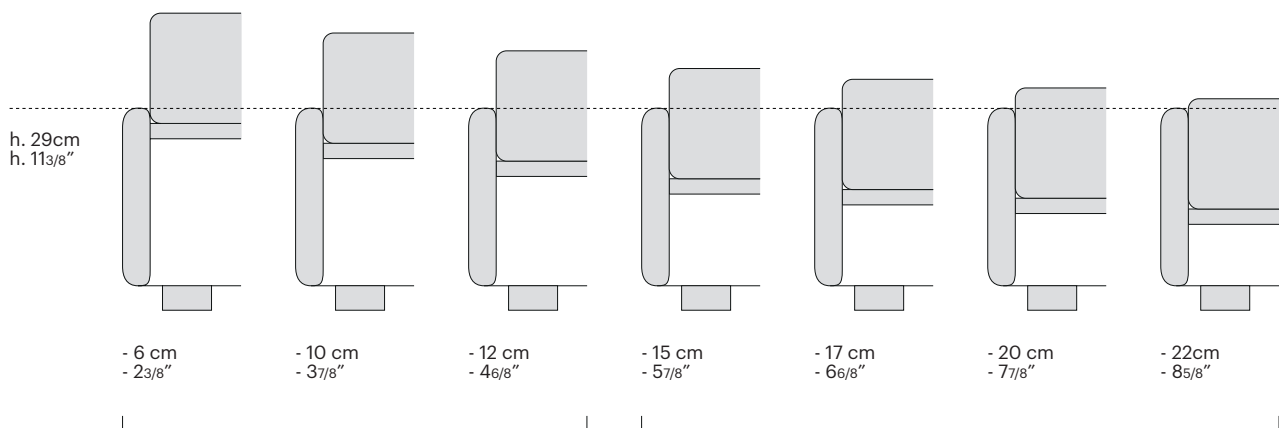

ribassamento disponibile per giroletto h. 20 e h. 29 cm /
mattress recess available for h. 20 and h. 29 cm bedframes

ribassamento disponibile solo per giroletto h. 29 cm /
mattress recess available for h. 29 cm bedframe