

capri

design bolzan LAB



Una semplicità che nasce da una profonda ricerca e cultura dell'arredo, per un letto che arricchisce lo spazio notte di una presenza rassicurante e raffinata. La testata imbottita, dalle linee armoniose, è proposta sia in versione liscia che con lavorazione capitonnè, mentre il giroletto può essere con piedini a vista o arricchito con un sartoriale ed elegante gonnellina.

A simplicity coming from a deep research and culture of furniture, for a bed that enriches the bedroom with a reassuring and refined presence. The padded headboard, with its harmonious lines, is available in both smooth and capitonné version, while the bedframe can be with visible feet or enriched with a tailored and elegant skirt.

informazioni tecniche / technical info:

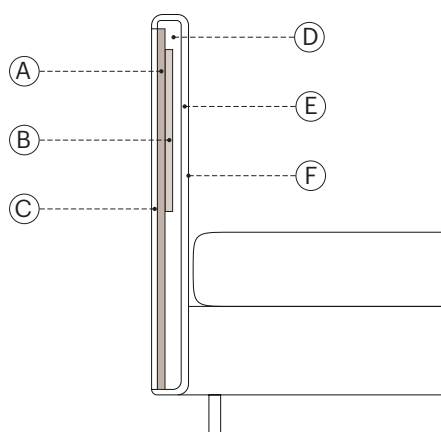

testata / headboard

- A. truciolare 20mm / 20mm chipboard
- B. multistrato pioppo 10 mm / 10 mm poplar plywood
- C. espanso ignifugo D 25 kg/mc / fire resistant foam D 25 kg/mc
- D. espanso ignifugo D 50 kg/mc / fire resistant foam D 50 kg/mc
- E. resinato poliestere ignifugo 100g / 100g fire resistant resin polyester fibre
- F. maglina polipropilene 70g / 70g polypropylene mesh

h 20

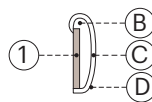

h 29

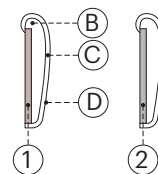

giroletti / bedframes

- 1. listellare abete 22mm 3 strati / 22mm 3-layer fir blockboard
- 2. estruso in alluminio 22mm / 22 mm extruded aluminum
- B. espanso ignifugo D 35 kg/mc / fire resistant foam D 35 kg/mc
- C. resinato poliestere ignifugo 100g / 100g fire resistant resined polyester fiber
- D. maglia polipropilene 70g / 70g polypropylene mesh

predisposto per materassi / for mattresses:

120	x	200	47 ² / ₈ "	x	78 ⁶ / ₈ "
160	x	200	63"	x	78 ⁶ / ₈ "
170	x	200	66 ⁷ / ₈ "	x	78 ⁶ / ₈ "
180	x	200	70 ⁷ / ₈ "	x	78 ⁶ / ₈ "

153	x	203	60"	x	80"	Queen size
193	x	203	76"	x	80"	King size

personalizzazioni disponibili / available customizations:



plane

capitonné

gonnellina / skirt

gonnellina / skirt
chic

Capri Plane / Firwood structure

Standard feet Vasetto - completely removable cover in fabric - non removable headboard cover in leather or eco-leather

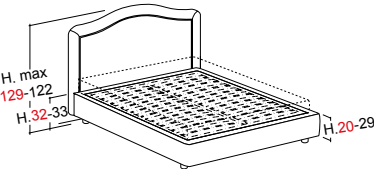
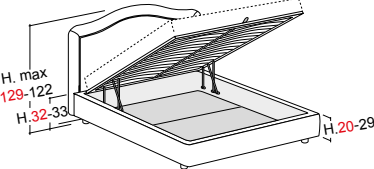
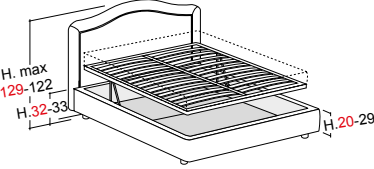
	Mattress	Ext. dimension	Code	D	C	A	Plus	Luxury fabric	Luxury leather	Nuvola fabric	Nuvola leather	TCL	Cover			
													ml	mc	kg	
rounded base h.20 - rounded base h.29 without slatted base (to choose a slatted base see flap on the right)																
 <p>H. max 129-122 H. 32-33 H. 20-29</p>	120x200	138x216	MRD29										7.5	0.36	56	
	150x200	168x216	MRI29										8.3	0.4	61	
	153x203 QUEEN 60x80"	171x219	MRQ29										8.3	0.4	61	
	160x200	178x216	MRM29										8.5	0.41	63	
	170x200	188x216	MRF29										9	0.42	68	
	180x200	198x216	MRG29										9.5	0.44	72	
	190x200	208x216	MRP29										10.5	0.47	78	
	193x203 KING 76x80"	211x219	MRK29										10.5	0.47	78	
	Loose cover			RMR										0.02		8
rounded base h.20 - rounded base h.29 w/BOX orthopaedic slatted base included suggested weights for mattresses (see flap on the right)																
 <p>H. max 129-122 H. 32-33 H. 20-29</p>	120x200	138x216	MRD29B										7.5	0.55	115	
	150x200	168x216	MRI29B										8.3	0.65	126	
	153x203 QUEEN 60x80"	171x219	MRQ29B										8.3	0.65	126	
	160x200	178x216	MRM29B										8.5	0.67	128	
	170x200	188x216	MRF29B										9	0.7	136	
	180x200	198x216	MRG29B										9.5	0.72	142	
	190x200	208x216	MRP29B										10.5	0.75	150	
	193x203 KING 76x80"	211x219	MRK29B										10.5	0.75	150	
	Loose cover			RMR										0.02		8
rounded base h.20 - rounded base h.29 w/easy-up BOX orthopaedic slatted base included suggested weights for mattresses (see flap on the right)																
 <p>H. max 129-122 H. 32-33 H. 20-29</p>	120x200	138x216	MRD29BE										7.5	0.59	125	
	150x200	168x216	MRI29BE										8.3	0.69	136	
	153x203 QUEEN 60x80"	171x219	MRQ29BE										8.3	0.69	136	
	160x200	178x216	MRM29BE										8.5	0.71	138	
	170x200	188x216	MRF29BE										9	0.74	146	
	180x200	198x216	MRG29BE										9.5	0.76	152	
	190x200	208x216	MRP29BE										10.5	0.79	160	
	193x203 KING 76x80"	211x219	MRK29BE										10.5	0.79	160	
	Loose cover			RMR										0.02		8

Capri plane / Aluminum structure

Standard feet Vasetto - completely removable cover in fabric - non removable headboard cover in leather or ecoleather

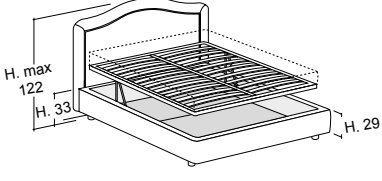
	Mattress	Ext. dimension	Code	D	C	A	Plus	Luxury fabric	Luxury leather	Nuvola fabric	Nuvola leather	TCL	Cover		
													ml	mc	kg
rounded base h.29															
without slatted base (to choose a slatted base see flap on the right)															
 <p>H. max 122 H. 33 H. 29</p>	120x200	138x216	MRD29A										7.5	0.36	57
	150x200	168x216	MRQ29A										8.3	0.4	64
	153x203 QUEEN 60X80"	171x219	MRQ29A										8.3	0.4	64
	160x200	178x216	MRM29A										8.5	0.41	66
	170x200	188x216	MRF29A										9	0.42	71
	180x200	198x216	MRG29A										9.5	0.44	76
	190x200	208x216	MRK29A										10.5	0.47	83
	193x203 KING 76X80"	211x219	MRK29A										10.5	0.47	83
	Loose cover		RMRA										8.5	0.02	8
rounded base h.29 w/BOX															
orthopaedic slatted base included suggested weights for mattresses (see flap on the right)															
 <p>H. max 122 H. 33 H. 29</p>	120x200	138x216	MRD29BA										7.5	0.55	116
	150x200	168x216	MRQ29BA										8.3	0.65	129
	153x203 QUEEN 60X80"	171x219	MRQ29BA										8.3	0.65	129
	160x200	178x216	MRM29BA										8.5	0.67	131
	170x200	188x216	MRF29BA										9	0.7	139
	180x200	198x216	MRG29BA										9.5	0.72	146
	190x200	208x216	MRK29BA										10.5	0.75	155
	193x203 KING 76X80"	211x219	MRK29BA										10.5	0.75	155
	Loose cover		RMRA										8.5	0.02	8
available inside height in Box 18cm															
rounded base h.29 w/easy-up BOX															
orthopaedic slatted base included suggested weights for mattresses (see flap on the right)															
 <p>H. max 122 H. 33 H. 29</p>	120x200	138x216	MRD29BEA										7.5	0.59	126
	150x200	168x216	MRQ29BEA										8.3	0.69	139
	153x203 QUEEN 60X80"	171x219	MRQ29BEA										8.3	0.69	139
	160x200	178x216	MRM29BEA										8.5	0.71	141
	170x200	188x216	MRF29BEA										9	0.74	149
	180x200	198x216	MRG29BEA										9.5	0.76	156
	190x200	208x216	MRK29BEA										10.5	0.79	165
	193x203 KING 76X80"	211x219	MRK29BEA										10.5	0.79	165
	Loose cover		RMRA										8.5	0.02	8
available inside height in Box 18cm															
rounded base h.29 w/HANDS FREE BOX															
orthopaedic slatted base included Specify mattress weight (see flap on the right)															
 <p>H. max 127 H. 38 H. 29</p>	150x200	168x219	MRL29BHF										8.3	0.69	135
	153x203 QUEEN 60X80"	171x222	MRQ29BHF										8.3	0.69	135
	160x200	178x219	MRM29BHF										8.5	0.71	137
	170x200	188x219	MRF29BHF										9	0.74	145
	180x200	198x219	MRG29BHF										9.5	0.76	153
	190x200	208x219	MRP29BHF										10.5	0.79	163
	193x203 KING 76X80"	211x222	MRK29BHF										10.5	0.79	163
	Loose cover		RMRHF										8.5	0.02	8
available inside height in Box 18cm															

Capri Capitonè / Firwood structure

Standard feet Vasetto - non removable headboard cover

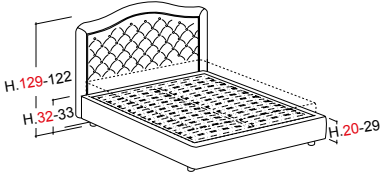
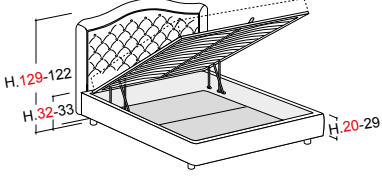
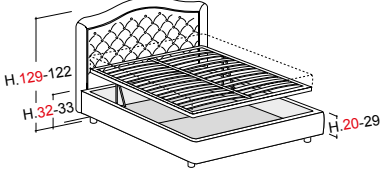
	Mattress	Ext. dimension	Code	D	C	A	Plus	Luxury fabric	Luxury leather	Nuvola fabric	Nuvola leather	TCL	Cover			
													ml	mc	kg	
rounded base h.20 - rounded base h.29 without slatted base (to choose a slatted base see flap on the right)																
	120x200	138x216	CAD29										8	0.36	60	
	150x200	168x216	CAL29										8.3	0.39	64	
	153x203 QUEEN 60X80"	171x219	CAQ29										8.3	0.39	64	
	160x200	178x216	CAM29										8.5	0.41	67	
	170x200	188x216	CAF29										9	0.42	72	
	180x200	198x216	CAG29										9.5	0.44	77	
	190x200	208x216	CAP29										10.5	0.47	84	
	193x203 KING 76X80"	211x219	CAK29										10.5	0.47	84	
	Loose cover			R29											0.02	5
	rounded base h.20 - rounded base h.29 w/BOX orthopaedic slatted base included suggested weights for mattresses (see flap on the right)															
	120x200	138x216	CAD29B										8	0.55	119	
	150x200	168x216	CAL29B										8.3	0.63	128	
	153x203 QUEEN 60X80"	171x219	CAQ29B										8.3	0.63	128	
	160x200	178x216	CAM29B										8.5	0.67	132	
	170x200	188x216	CAF29B										9	0.7	140	
	180x200	198x216	CAG29B										9.5	0.73	147	
	190x200	208x216	CAP29B										10.5	0.77	156	
193x203 KING 76X80"	211x219	CAK29B										10.5	0.77	156		
available inside height in Box 12-18cm																
Loose cover			R29B											3.5	0.02	5
rounded base h.20 - rounded base h.29 w/easy-up BOX orthopaedic slatted base included suggested weights for mattresses (see flap on the right)																
	120x200	138x216	CAD29BE										8	0.59	129	
	150x200	168x216	CAL29BE										8.3	0.67	138	
	153x203 QUEEN 60X80"	171x219	CAQ29BE										8.3	0.67	138	
	160x200	178x216	CAM29BE										8.5	0.71	142	
	170x200	188x216	CAF29BE										9	0.74	150	
	180x200	198x216	CAG29BE										9.5	0.77	157	
	190x200	208x216	CAP29BE										10.5	0.81	166	
193x203 KING 76X80"	211x219	CAK29BE										10.5	0.81	166		
available inside height in Box 12-18cm																
Loose cover			R29BE											3.5	0.02	5

Capri Capitoné / Aluminum structure

Standard feet Vasetto - non removable headboard cover

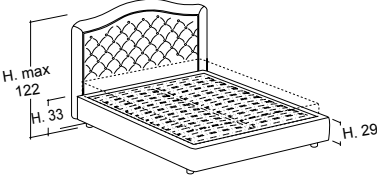
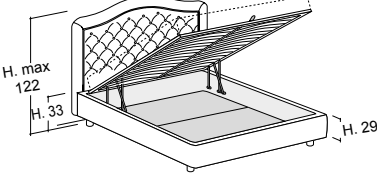
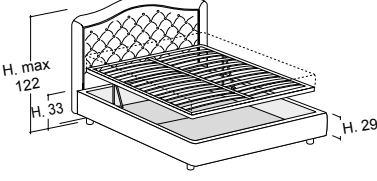
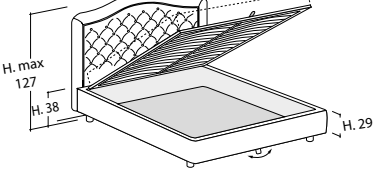
	Mattress	Ext. dimension	Code	D	C	A	Plus	Luxury fabric	Luxury leather	Nuvola fabric	Nuvola leather	TCL	Cover			
													ml	mc	kg	
rounded base h.29																
without slatted base (to choose a slatted base see flap on the right)																
	120x200	138x216	CAD29A										8	0.36	61	
	150x200	168x216	CAL29A										8.3	0.39	67	
	153x203 QUEEN 60X80"	171x219	CAQ29A										8.3	0.39	67	
	160x200	178x216	CAM29A										8.5	0.41	70	
	170x200	188x216	CAF29A										9	0.42	75	
	180x200	198x216	CAG29A										9.5	0.44	81	
	190x200	208x216	CAP29A										10.5	0.47	89	
	193x203 KING 76X80"	211x219	CAK29A										10.5	0.47	89	
	Loose cover			R29A											0.02	5
rounded base h.29 w/BOX																
orthopaedic slatted base included suggested weights for mattresses (see flap on the right)																
	120x200	138x216	CAD29BA										8	0.55	120	
	150x200	168x216	CAL29BA										8.3	0.63	131	
	153x203 QUEEN 60X80"	171x219	CAQ29BA										8.3	0.63	131	
	160x200	178x216	CAM29BA										8.5	0.67	135	
	170x200	188x216	CAF29BA										9	0.7	143	
	180x200	198x216	CAG29BA										9.5	0.73	151	
	190x200	208x216	CAP29BA										10.5	0.77	161	
	193x203 KING 76X80"	211x219	CAK29BA										10.5	0.77	161	
	Loose cover			R29BA											3.5	0.02
rounded base h.29 w/easy-up BOX																
orthopaedic slatted base included suggested weights for mattresses (see flap on the right)																
	120x200	138x216	CAD29BEA										8	0.59	130	
	150x200	168x216	CAL29BEA										8.3	0.67	141	
	153x203 QUEEN 60X80"	171x219	CAQ29BEA										8.3	0.67	141	
	160x200	178x216	CAM29BEA										8.5	0.71	145	
	170x200	188x216	CAF29BEA										9	0.74	153	
	180x200	198x216	CAG29BEA										9.5	0.77	161	
	190x200	208x216	CAP29BEA										10.5	0.81	171	
	193x203 KING 76X80"	211x219	CAK29BEA										10.5	0.81	171	
	Loose cover			R29BEA											3.5	0.02
rounded base h.29 w/HANDS FREE BOX																
orthopaedic slatted base included Specify mattress weight (see flap on the right)																
	150x200	168x219	CAL29BHF										8.3	0.67	137	
	153x203 QUEEN 60X80"	171x222	CAQ29BHF										8.3	0.67	137	
	160x200	178x219	CAM29BHF										8.5	0.71	141	
	170x200	188x219	CAF29BHF										9	0.74	149	
	180x200	198x219	CAG29BHF										9.5	0.77	158	
	190x200	208x219	CAP29BHF										10.5	0.81	169	
	193x203 KING 76X80"	211x222	CAK29BHF										10.5	0.81	169	
Loose cover			R29HF											3.5	0.02	5

GIROLETTI E PIEDINI / BEDFRAMES AND FEET

bedframe h.9 cm



cilindro
H 26 cm 10²/₈"



vasetto
H 26 cm 10²/₈"



vasetto inclinato
H 26 cm 10²/₈"



tubino
H 26 cm 10²/₈"



lamina
H 26 cm 10²/₈"



arco
H 26 cm 10²/₈"

bedframe h.20 cm



cilindro
H 12,5 cm 4⁷/₈"



vasetto
H 12,5 cm 4⁷/₈"



tubino
H 12,5 cm 4⁷/₈"



lamina
H 15 cm 5⁷/₈"

bedframe h.29 cm



vasetto h. 4cm
H 4 cm 1⁵/₈"



vasetto h. 9-12,5 cm
H 9 cm 3⁴/₈"
H 12,5 cm 4⁷/₈"



cipolla
H 8 cm 3¹/₈"

pedini in legno / wooden feet:

pedini realizzati in legno di pincopallo con possibilità di essere tinti, verniciati ral o foderati in tessuto a scelta.

pedini realizzati in legno di pincopallo con possibilità di essere tinti, verniciati ral o foderati in tessuto a scelta.

finiture legno tinto / lacquered wood finishes:



noce / walnut



ciliegio / cherry



rovere / oak



wengè

pedini in metallo / metal feet:

pedini realizzati in acciaio con possibilità di essere verniciati effetto ottone o colori ral.

pedini realizzati in acciaio con possibilità di essere verniciati effetto ottone o colori ral.

finiture metallo / metal finishes:



ottone satinato /
brushed brass

finiture laccati ral / ral lacquered finishes:



bianco / white
RAL 9010



perla / pearl
RAL 1013



nero / black
RAL 9011



grigio / grey
RAL 7044



marrone / brown
RAL 8019



rosso / red
RAL 3005



verde / green
RAL 6020



blu / blue
RAL 5008

h. 20-29 SISTEMA CONTENITORE / BOX SYSTEM



box

BOX

apertura basic del box grazie ad un semplice sistema a leva / basic opening of storage box thanks to a simple lever system

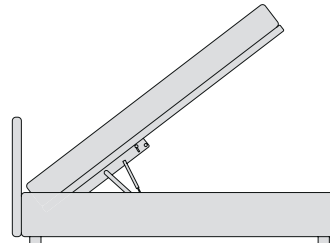

interno in legno



interno in alluminio

HANDS-FREE

apertura del box senza l'uso delle mani e grazie al box completamente in alluminio è privo di pistoncini a vista / The mechanism allows to open the storage box without hands, and thanks to its aluminum structure, the storage box has inner pistons, thus maintaining a top-notch design

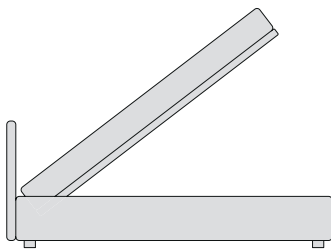

interno in alluminio

EASY UP

grazie al movimento che mantiene la rete all'interno dello spazio occupato dal letto, ottimizza lo spazio all'interno della stanza / mechanism optimizes the space inside the room thanks to its movement that keeps the slatted base within the space occupied by the bed

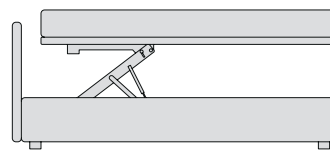

interno in legno



interno in alluminio

h. 20-29 INCASSO MATERASSO / MATTRESS RECESS

La struttura dei letti Bolzan permette di soddisfare le diverse esigenze di progettazione: l'incasso del materasso nella struttura del letto è personalizzabile in 7 altezze diverse. Non disponibile per le basi con box.

Bolzan beds' structure allows you to meet different design needs: the mattress recess in the bed's structure is customizable in 7 different heights. It is not available for bases with box.

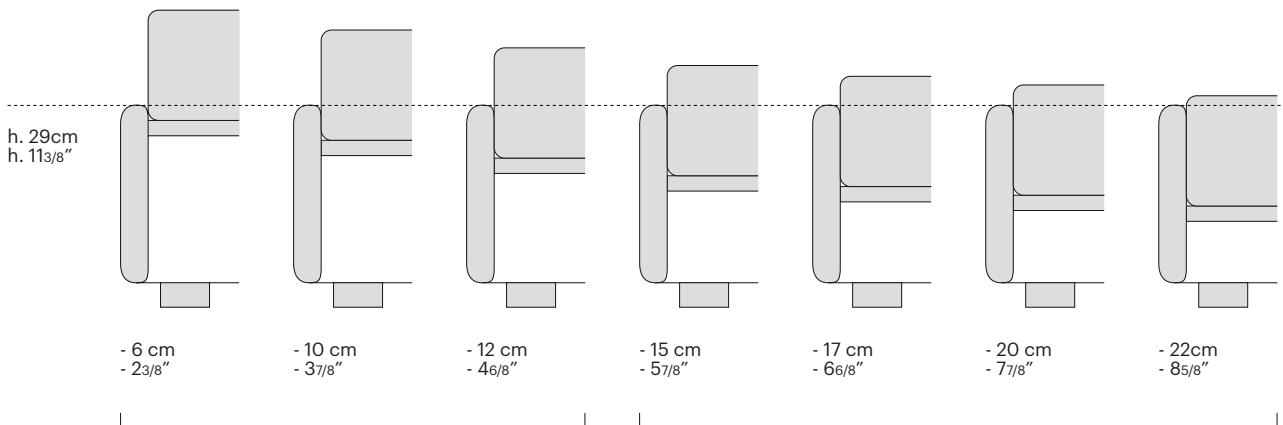

ribassamento disponibile per giroletto h. 20 e h. 29 cm / mattress recess available for h. 20 and h. 29 cm bedframes

ribassamento disponibile solo per giroletto h. 29 cm / mattress recess available for h. 29 cm bedframe